

User Manual

Indoor FHD Pan/Tilt IP Camera



Model: FI9926P/Z2/FI9936P

Table of Contents

Security Warning	1
1 Overview.....	1
1.1 Key Features.....	1
1.2 Read Before Use.....	2
1.3 Package Contents.....	2
1.4 Physical Description.....	2
1.5 Hardware Installation	4
2 Access the IP Camera.....	5
2.1 Hardware Connection & Software Installation	5
2.2 Access the Camera in LAN.....	5
2.3 Access the Camera in WAN.....	6
2.4 Using the VLC player	7
2.5 IP camera connection to the server	9
3 Surveillance Software GUI	10
3.1 login Window.....	10
3.2 Setup Wizard.....	11
3.3 Surveillance Window.....	13
4 Advanced Camera Settings.....	21
4.1 Setup Wizard.....	21
4.2 Status	21
4.3 Basic Settings	23
4.4 Network	29
4.5 Video	38
4.6 Detector.....	42
4.7 Record.....	46
4.8 PTZ.....	50
4.9 Firewall	54
4.10 System	55
5 Playback	59
6 Appendix.....	61
6.1 Frequently Asked Questions.....	61
6.2 Default Parameters	68
6.3 Specifications	68
6.4 CE & FCC	70
6.4 Warranty.....	71
6.5 Statement	73
7 Obtaining Technical Support	75

Security Warning

1. Please change the password of your camera regularly, using a combination of numbers, letters and special characters.
2. We recommend that you regularly update your camera to the latest available software and firmware versions to help ensure the best experience for your camera.

1 Overview

FOSCAM Indoor FHD IP camera is an integrated wireless IP Camera with a color CMOS sensor which enable to view in High Definition resolution. It combines a high quality digital video camera, with a powerful web server, to bring clear video to your desktop and mobile devices no matter where by your local network or over the Internet.

These cameras support P2P function. Thanks to the P2P easy access technology, you don't need to do complicated Port Forwarding settings, you just need to scan the QR code on the bottom of the camera to connect it to smart phone, or input the UID on CMS software to realize remote access.

With flexible move of 340-degree horizontally and 120-degree vertically, FOSCAM IP Camera provides users with more comprehensive controls over a monitored site. The camera supports H.264 video compression technology, dramatically reduces file size and saves network bandwidth.

The camera is based on the TCP/IP standard. A built-in WEB server inside which could support Internet Explorer simplifies the management and maintenance of your device is simplified by accessing the website of your camera through network.

The camera is designed for indoor surveillance with wide applications such as at home, in retail store and in office. Controlling the camera and managing images are simplified by using the provided web interface across the network in either wired or wireless way.

FOSCAM provides Smart Phone App for Android and iPhone users, please search and install Foscam App named Foscam on App Store and Google Play for iOS and Android devices, then you can view your camera anywhere, anytime on your smart mobile devices.

1.1 Key Features

- Standard H.264 video compression algorithm to satisfy the transmission of high definition video in narrow bandwidth network
- P2P feature for easy access
- Megapixel HD video
- Pan 340 degree, tilt 120 degree

- Support IE/Firefox/Google/Safari browser
- Support WPA-PSK and WPA2-PSK Encryption
- Wireless connection is compliant with IEEE 802.11b/g/n WI-FI, up to 150Mbps
- IR Range up to 8m(26ft)
- Support image snapshot
- Support dual-stream
- Support SD Card storage up to 128GB
- Support IR-Cut auto switch
- Support two-way audio
- Support ONVIF protocols
- Multi-level users management with password protection
- Motion detection alert via email or upload image to FTP
- Provide free Android and iPhone APP for viewing live video provide free Central Management Software to manage and monitor multiple cameras
- Support record schedule

1.2 Read Before Use

Please first verify that all contents received are complete according to the Package Contents listed below. Before the IP Camera is installed, please carefully read and follow the instructions in the Quick Setup Guide to avoid damage due to faulty assembly and installation. It also ensures the product is used properly as intended.

1.3 Package Contents

● IP Camera × 1	● DC Power Adapter × 1
● WI-FI Antenna × 1	● Mounting bracket × 1
● Quick Setup Guide × 1	

1.4 Physical Description

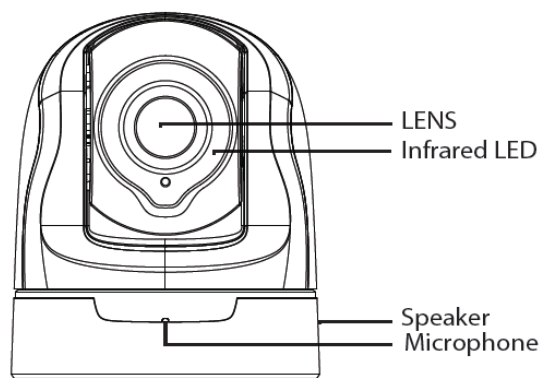

1.Speaker: Built-in speaker

-
- 2.LENS:** Fixed focus lens
 - 3.Infrared LED:** Infrared LEDs for night vision
 - 4.Microphone:** Built-in microphone

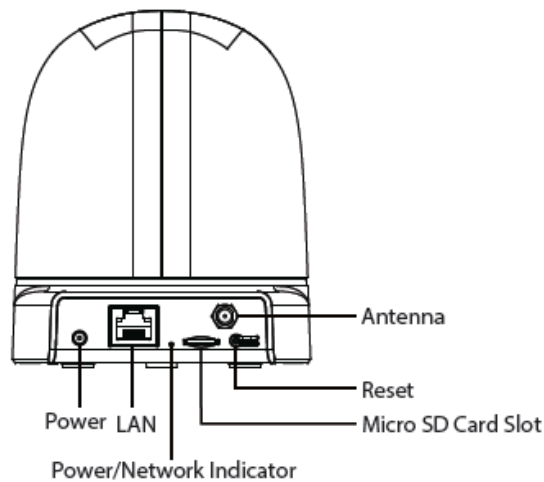

- LAN: 10/100 Mbps RJ-45 port for wired connection
- Power: DC 5V/2A Power supply
- SD card Slot: Supports up to 32GB SD card for storing the video
- Antenna: Used to connect external wireless antenna
- Reset Button: Push and hold for more than 5 seconds to set the camera to factory default.

Bottom View

There are some labels located of the camera; this is an important feature of original Foscam cameras. If your camera does not have labels, it may be a clone. Cloned Foscam cameras can not use original firmware and are not eligible for warranty or technical services.



Mounting Port: Port for mounting bracket

The flashing status of the Power light and Network light are shown in the following table.

Light	Flashing Status	Description
Power light	off	The power don't work properly.
	on	The power supply works fine.
Network light	off	No Wireless connection
	Slow Flash once per second	Wireless connection
	Flashing every 0.4 seconds	WPS is connecting
	Flashing every 0.2 seconds	EZLink takes effect
	Constant for 3 seconds one time	Reset to take effect

1.5 Hardware Installation

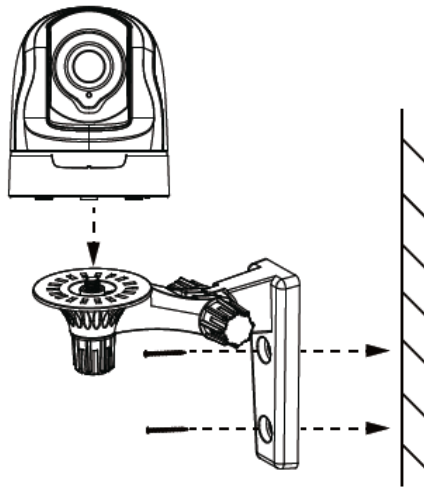

Step 1: Screw the mount on the wall with the two screws provided.

Step2: Loosen the thumb screws to adjust the mount to the desired position. Once the position is set, tighten the screws securely.

2 Access the IP Camera

2.1 Hardware Connection & Software Installation

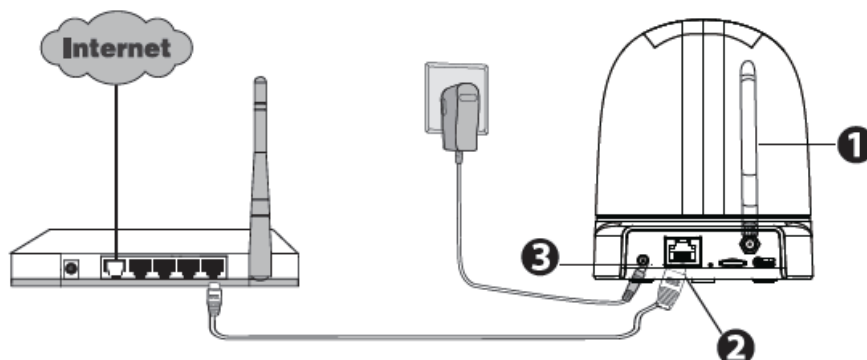

1. Mount the antenna and make it stand vertically.
2. Connect the camera to the LAN network (Router or Switch) via network cable.
3. Connect the power adapter to the camera.
4. Visit Foscam official website <http://www.foscam.com> , select “Support > Download Center > Software Tools”, then you can find the “Equipment Search Tool”, download the tool to your computer, the icon shows as below:



2.2 Access the Camera in LAN

The camera supports HTTP and HTTPS protocols, you can access the camera in two ways.

(1) `http:// LAN IP + HTTP Port NO.`

The default HTTP port NO. is 88. Double click the Equipment Search Tool icon to run, and it should find the camera’s IP address automatically after you plug in the network cable.

Camera Name	IP Address	Device ID	Type
Anonymous	Http://192.168.1.105:88	00626E55AB1E	IPC

Double click the IP address of the camera; the camera login page should be open in your default browser.

(2) https:// LAN IP + HTTPS Port NO.

The default HTTPS port NO. is 443. You can use the URL to access the camera: https:// LAN IP + HTTPS port NO.

Go to **Settings - Network - Port** panel, you can see and change the HTTP and HTTPS port NO.

Save Refresh	
HTTP Port	88
HTTPS Port	443
ONVIF Port	65533

NOTE:

When logging in for the first time, you will need to download and install the add-on.

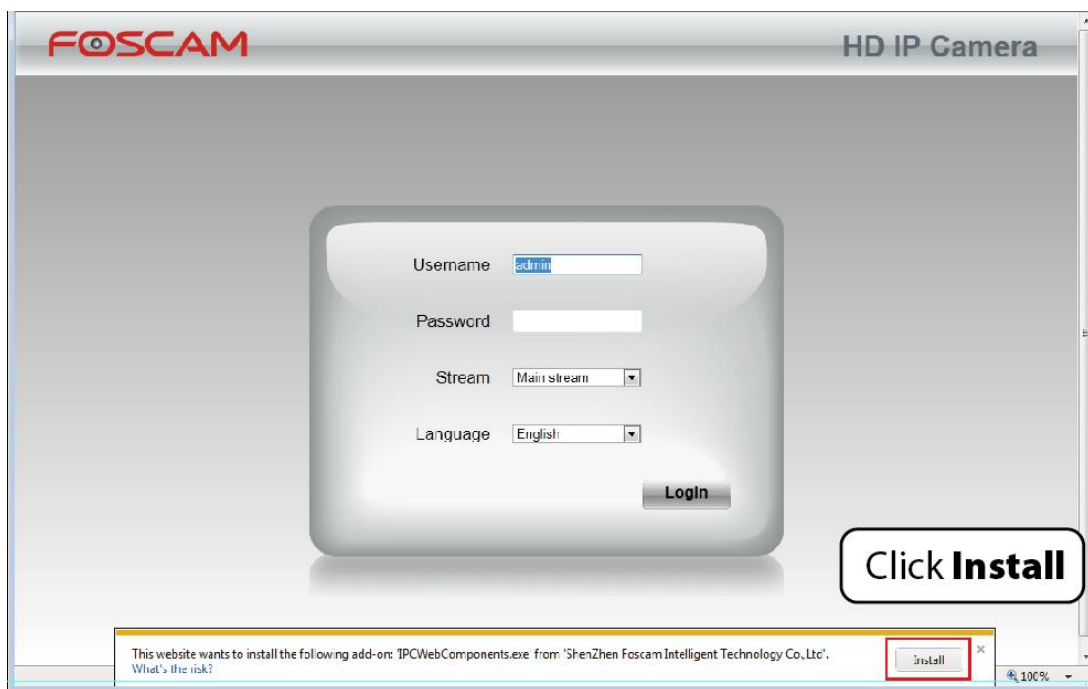

2.3 Access the Camera in WAN

2.3.1 Static IP Addresses

Users with static IP addresses after you have finished connecting the camera using the LAN IP address and port forwarding, you can access the camera directly from Internet using the WAN IP address and port number.

How to Obtain the WAN IP address from a public website ?

To obtain your WAN IP address, enter the following URL in your browser: <http://www.whatismyip.com>. Your current WAN IP will be shown on the webpage.



2.4 Using the VLC player

The camera supports RTSP streaming, here you can view the camera by VLC player.

RTSP URL [rtsp:// \[user name\]:\[password\]@IP:port number/videosream](rtsp://[user name]:[password]@IP:port number/videosream)

The part in the square brackets can be omitted.

user name & password: The user name and password to access the camera. This part can be omitted.

IP: WAN or LAN IP address.

Port number : If there is the RTSP port number on the Port page, you must only use RTSP port number. otherwise, you must only use http port number.

Video stream: Three modes are supported: video Main, video Sub and audio. Video Sub is a better choice in bad network condition. If you select audio, you can only hear sound without seeing picture.

For example:

IP: 192.168.1.11

Port number: 88

User name: admin

Password: 123

Enter either one of the following four URLs in the VLC

1. `rtsp://admin:123@192.168.1.11:88/videoMain`
2. `rtsp:// @192.168.1.11:88/videoMain`
3. `rtsp://:123@192.168.1.11:88/videoMain`
4. `rtsp://admin@192.168.1.11:88/videoMain`

Open the VLC, and go to "Media"--"Open Network Stream" option, then enter the URL in VLC.

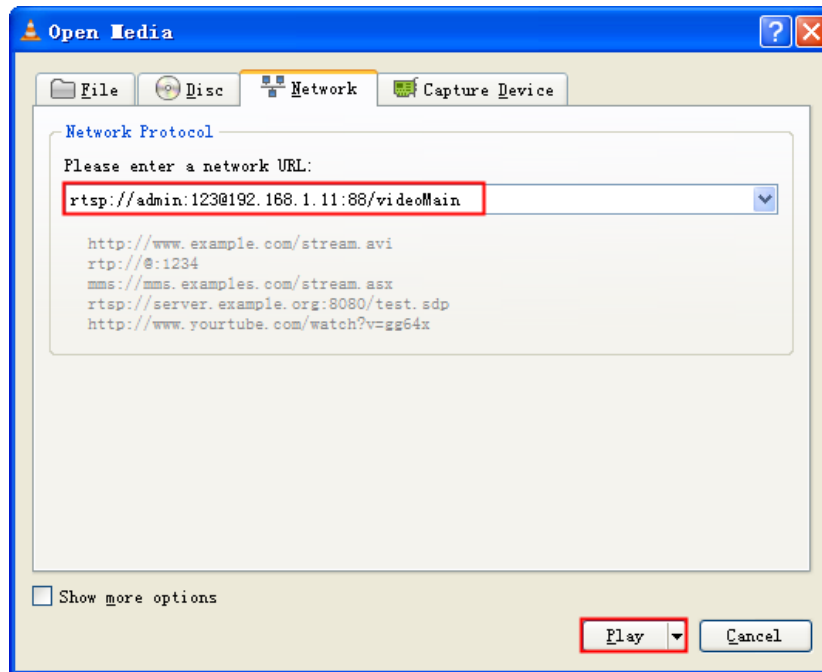
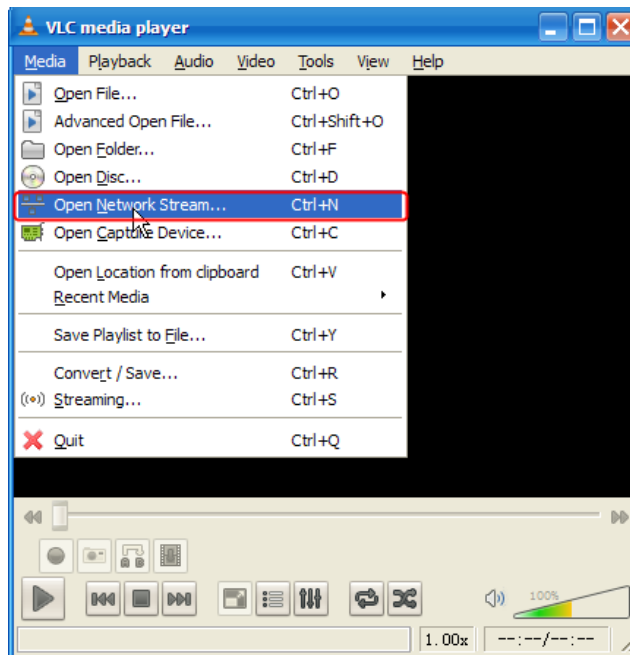

Sometimes you may need to enter the user name and password for another time. Click OK and you can see the real-time preview.

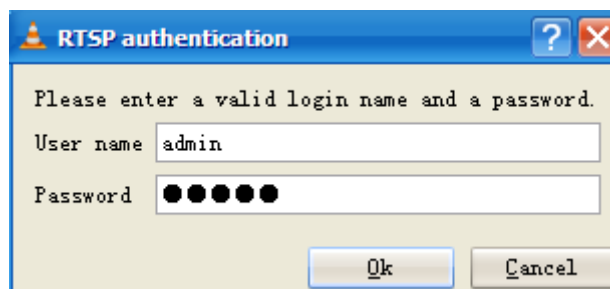

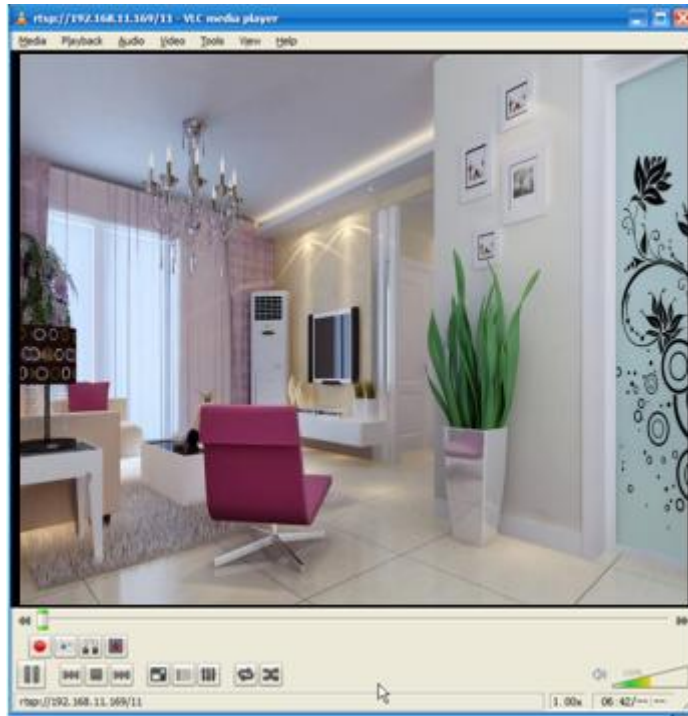

If you cannot play the video in the VLC player, please check the port mapping.

NOTE:

If you modify the camera's username or password, you had better reboot the camera to apply the new username and password in authentication in the VLC.

2.5 IP camera connection to the server

Device supports ONVIF 2.2.1 protocol, You can easily access NVR with ONVIF or server with ONVIF.

3 Surveillance Software GUI

Please refer to the section 2.1 if you install the camera for the first time. You can start to learn about software operation after finish quick installation.

3.1 login Window

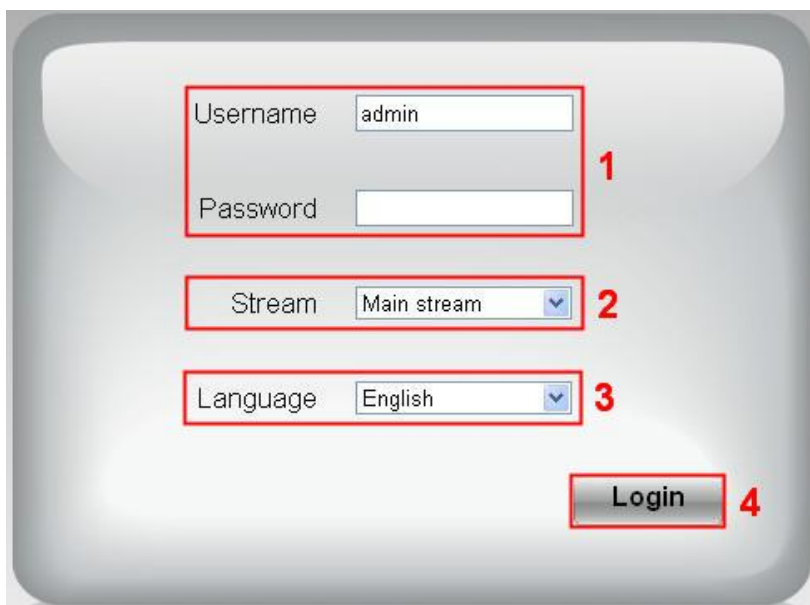

Section1 Enter the Username and password

The default administrator username is “admin” with no password, please change the password the first time you use and prevent unauthorized users login the camera.

Section2 Stream

The camera supports two stream modes: Main stream and sub stream. Select Main stream if you want to access the camera from LAN and sub stream will be better if you want to access the camera from Internet.

Note:

Select sub stream to ensure a more fluent video under narrow network bandwidth.

Section3 Select the language

You click on the language dropdown list to select language.

Section4 login the camera

Click “login” button.

NOTE:

When setting up your camera for the first time, it will request that you modify the default username and/or password if both are still set to default. Input the new username and password, click "Modify" to complete the modification. You will now use the new username and password to login to the camera in the future.

3.2 Setup Wizard

You will go to "Setup Wizard" automatically after your first-login, where you can set the basic parameters of camera, such as camera name, camera time, wireless settings, IP configuration.

Device Name: You could give name for your camera.

System Time: Select the time zone you need to set the date, time,format and so on.

Setup Wizard

Step 2 of 4 - Camera Time

Time Zone: (GMT) Greenwich mean time; London, Lisbon, ▾

Sync with NTP server

NTP Server: time.nist.gov ▾

PC Time: 2014-1-1 12:17:29 PM

Date Format: YYYY-MM-DD ▾

Time Format: 12-hour ▾

use DST

Ahead Of Time: 0 Minute

Wireless networks: Click “Scan” , find the SSID of your wireless router, select and enter the password.

Setup Wizard

Step 3 of 4 - Wireless Settings

Wireless Network List 1

SSID(Network Name)	Encryption	Quality
Tenda_373678	WPA/WPA2	
dlink-chenchen2.4G	WPA/WPA2	
TP_LINK_TEST	WPA2	
FOSCAM-docdev	WPA/WPA2	

2

SSID	FOSCAM-docdev
Encryption	WPA/WPA2 ▾
Password	●●●●●●●●

3

The maximum password length is 63, including numbers, letters and symbols

IP: Set IP address of the camera. You could obtain an IP automatically or set the IP address according to your needs.

Setup Wizard

Step 4 of 4 - IP Configuration

Obtain IP From DHCP

IP Address	192.168.1.101
Subnet Mask	255.255.255.0
Gateway	0.0.0.0
Primary DNS Server	0.0.0.0
Secondary DNS Server	0.0.0.0

Note: Once you save your settings, the camera will restart.

3.3 Surveillance Window

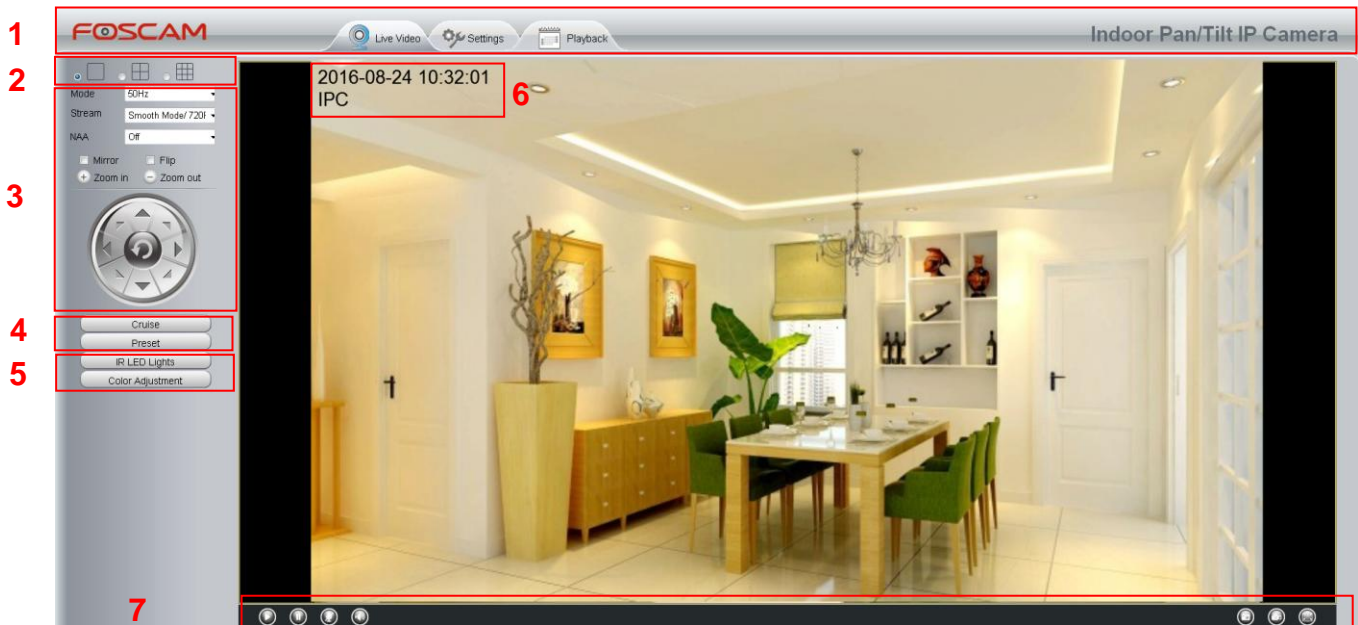

Section 1 FOSCAM Logo/ Live Video / Settings/Playback buttons

FOSCAM: FOSCAM LOGO

LiveVideo: Path to surveillance window. Click this button to go back to the surveillance window

Settings: Path to Administrator Control Panel, Click it, to go to Administrator Control Panel and do advanced settings.

Playback: Click this button to go back to the Playback panel to view the stored audio files stored in the SD Card.

Section 2 Multi-Device Window

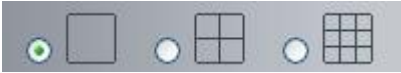

The firmware inside the camera supports up to 9 cameras being monitored at the same time. You can add other cameras in multi-device setting .

Section 3 Mode/ Stream / NAA / Mirror/ Flip buttons

Mode

- 1) 50HZ -----Indoor surveillance (Region: Europe, China)
- 2) 60HZ -----Indoor surveillance (Region: USA, Canada)
- 3) Outdoor-----Outdoor surveillance

Stream

The default stream supports multiple modes, For example: HD Mode/720P/30fps/2M meanings: Stream type / Resolution / Maximum frame rate/ Bit rate. (Different models support different specific mode.)

1) Stream type : It is used to identify the stream type.

2) Resolution

The bigger the resolution, the better of the image quality is. If you are accessing the camera via internet and want to get more fluent video streaming, please select resolution VGA.

3) Maximum frame rate

The maximum frame rate is 30 fps. You should lower frame rate when the bandwidth is limited. Normally, when the frame rate above 15, you can achieve fluently video. The maximum frame rate for each model is different.

4) Bit rate

Generally speaking, the larger the bit rate is, the clearer video will become. But the bit rate configuration should combine well with the network bandwidth. When the bandwidth is very narrow, and bit rate is large, that will lead to video can not play well.

You can reset the stream type on **Settings-> Video-> Video Settings** panel.

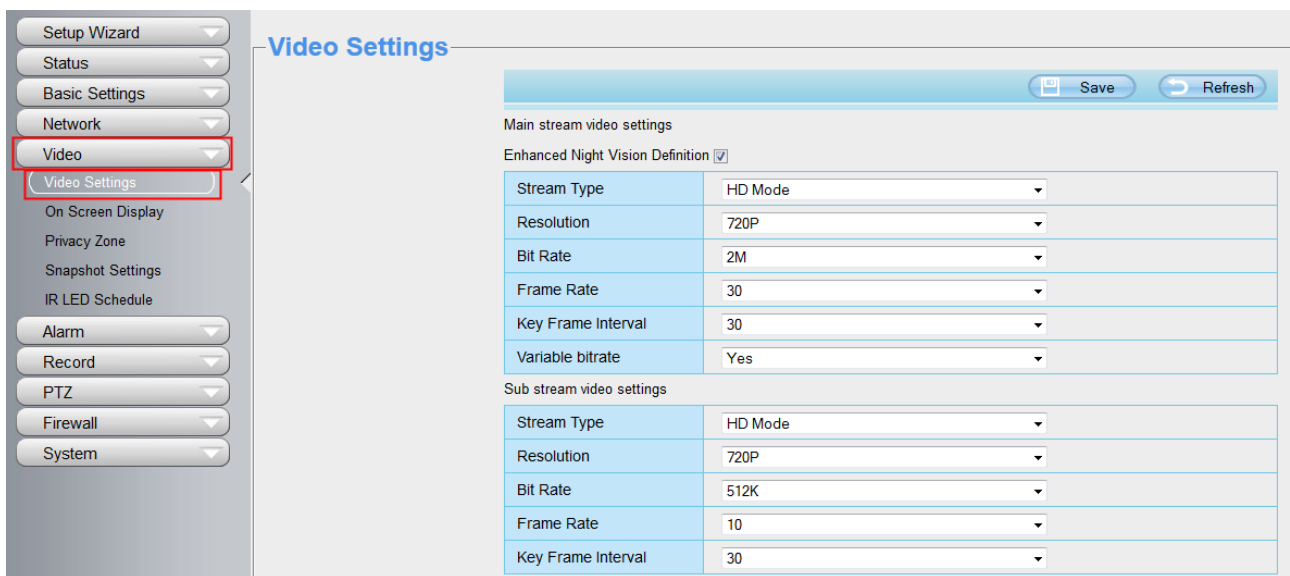

After changing, please re-login the camera and you can see the modification.

NAA(Network Auto-Adaptability)

When you turn NAA on, IP camera can change the real-time rate to adapt different network conditions. It can supply better preview experience. The default NAA setting is off.

Zoom Control

+ Zoom in Zoom in the camera's lens.

- Zoom out Zoom out the camera' lens.

You can adjust the speed of the lens' zoom in **Settings--PTZ--Pan & Tilt Speed--Zoom speed** panel.

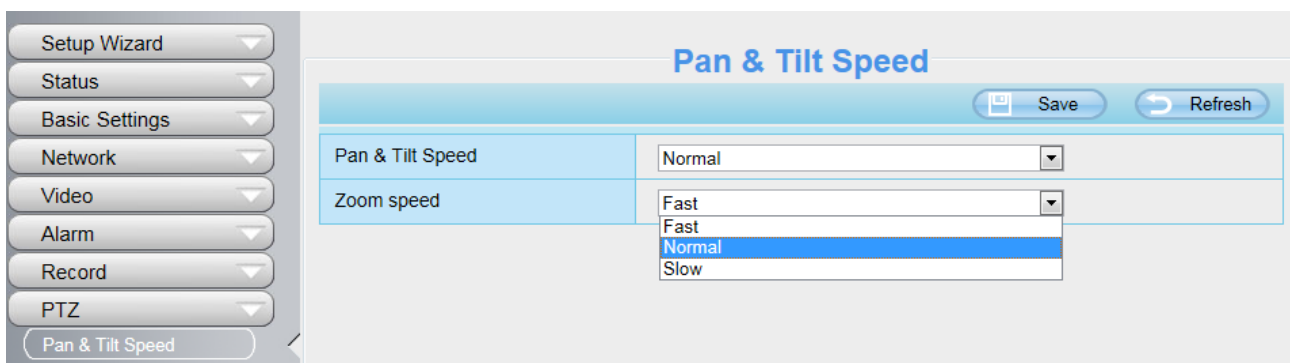

Pan/Tilt Control



- 1----- Up control button,
- 3-----Left control button,
- 5----- Up-Left control button
- 6----- Up-Right control button
- 7----- Down-Left control button
- 8----- Down-Right control button

- 2-----Down control button,
- 4-----Right control button,



Click this button and go to center

Section 4 Cruise / Preset settings

Cruise Settings



The default cruise tracks have two types: Vertical and Horizontal.

Vertical: The camera will rotate from up to down.

Horizontal: The camera will rotate from left to right.



: Start cruise.



: Stop cruise.

If you want to define or change the cruise trace, please go to **Settings** → **PTZ Preset Settings** panel.

How to do cruise?

Firstly: Select one track in the track dropdown list.

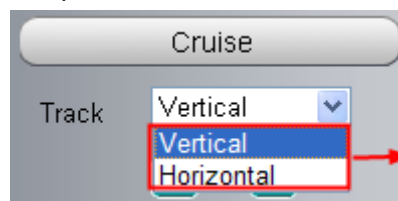

Select one of these.

Secondly: Click Start cruise button, the camera will cruise following the predefined path.

Thirdly: Click stop button and finish cruising.

Preset settings



IPCam supports 16 preset positions, which is considered enough for DIY home & small business surveillance market

The default preset position is Topmost, Bottom most, Left most, right most, you can add other preset positions.



Add Click this icon to save the position you need the camera to remember



Delete Select one preset position and click this button to delete it.



GO Select one preset position in the preset drop-down list and click Go to make the camera move the preset position

How to do preset position?

Firstly, move the camera and stop at a desired place where you want make preset position.

Secondly, click  button and enter a descriptive name for the preset position. The preset position cannot contain special characters. Then click OK to save it. If you want to reset the preset position, click Cancel.

After that, you can move the camera and stop at another place, and set another preset position. You can do all the 16 preset positions with this method.

If you want to see one preset position you have set, only select the preset position name from the preset drop-down list, and click go  button, the camera will go to the preset position.

Section 5 IR LED Lights / Color Adjustment



Click Infra led and there are three modes to adjust the infrared led: Auto, Manual and Schedule.

Auto: Select it and the camera will adjust the infra led (on or off) automatically.

Manual: Select it and you can turn on or turn off the infra led manually.

Schedule: Select it and the IR led light will be off at the schedule period. If you want to define or change the IR led lights schedule time, please go to **Settings--->Video---> IR LED Schedule** page.

Color Adjustment

In this page, you can tune Hue, Brightness, Contrast, Saturation, and Sharpness to get higher quality.



Section 6 OSD

If you have added time and camera name in the video, you can see it in the live window.

Go to **Settings ---Basic settings---Camera name** panel, and you can change another device name. The default device name is anonymous.

Go to **Settings ---Basic settings---Camera time** panel and adjust the device time.

Go to **Settings ---Video---On Screen Display** panel, you can add or no add OSD.

Section 7 Play/ Stop/ Talk/ Audio/ Snapshot/ Record/ Full screen button



1---- Play Click it to play the video of the camera

2---- Stop Click it to stop the video of the camera

3---- Talk Click the button and the icon will become to , then talk to the microphone that connected with PC, people around the camera can here your voice. Click the icon again and stop talking.

4---- Audio Click this icon, the icon will become to  you can hear the sound around the camera by the earphone or speakers that connected with PC.

5---- Snapshot Click it to make snapshot and it pop-up a window which picture you snapshot, right click in the window and save the picture to anywhere you want.

6---- Record Click the icon  and the camera start recording, you can see a green dot in the live window. Click again and stop recording. The default storage path is C:\IPCamRecord. You can change the storage path: Go to Settings- >Record->Storage Location panel.

7----- Full Screen Click it to make full-screen, or you can double click the surveillance screen to make full-screen. Double click again and exit full-screen.

Onscreen Mouse Control

Right click the mouse and you can adjust the screen ration, full screen and Zoom up.

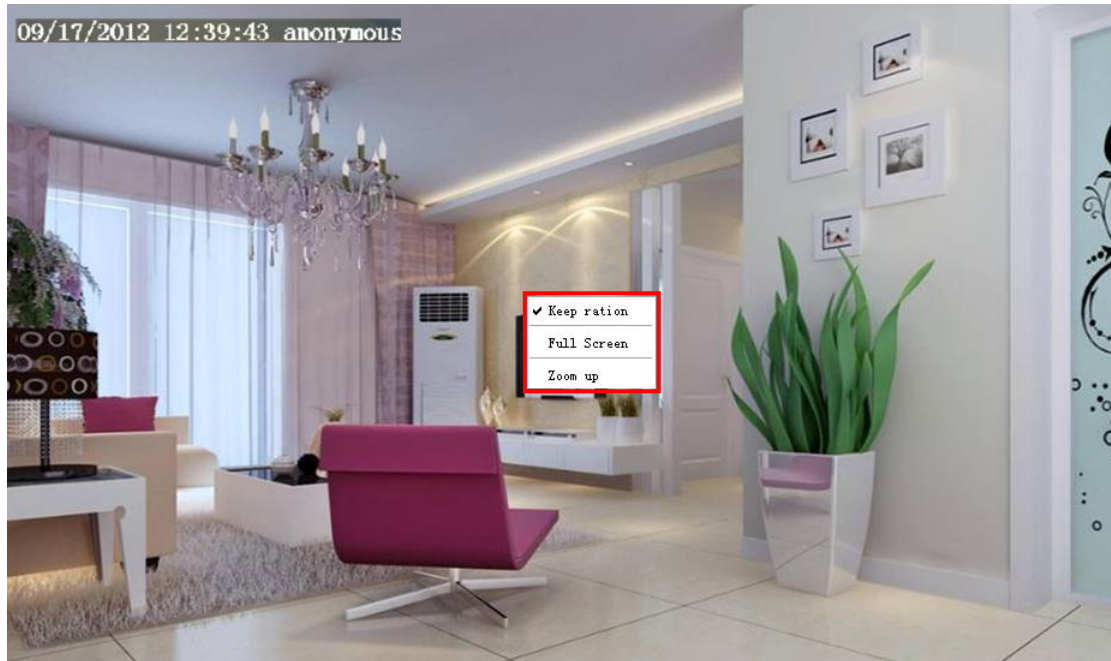

Keep ration: Select it and the camera will adjust the size of live window based on the the computer monitor automatically. Sometimes there is a black border around the video, please select Keep ration to get a better visual quality .

Full Screen: Select it and Click it to make full-screen, press ESC and exit full-screen.

Zoom up: Select it and you can see a bigger screen than before.

First Method: Here is a convenient and fast solution to Zoom up/down screen by Clicking Video Screen and adjusting Mouse pulley, or by press the CTRL key and click the mouse left button.

Second Method: Click it and the live view will be digital zoomed up, then click Zoom Down and the live view back to original size.

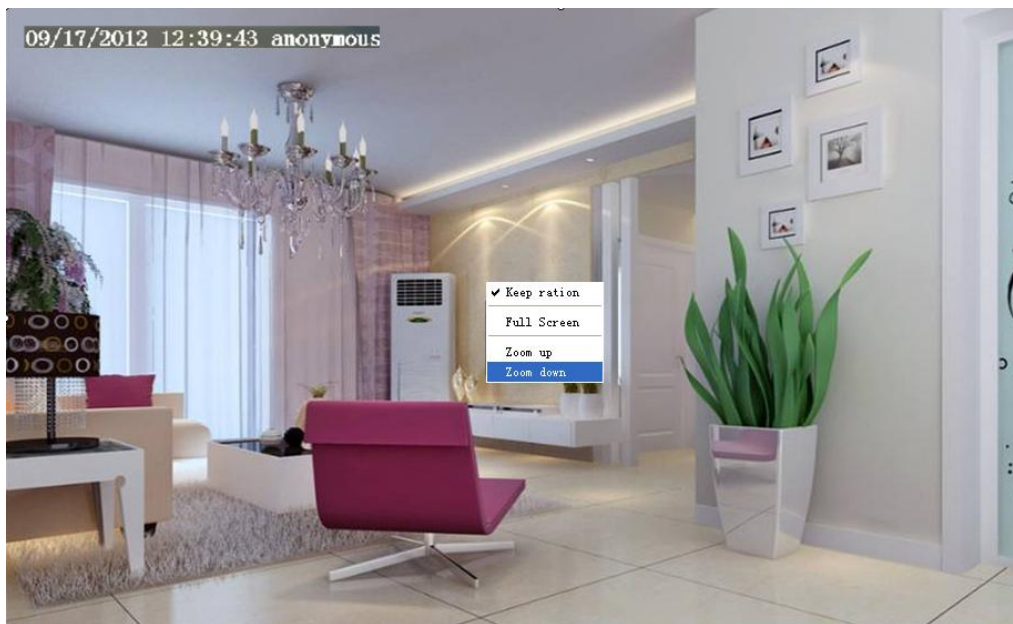

When you select the Full Screen, then click right mouse, there is a Screen PTZ button.

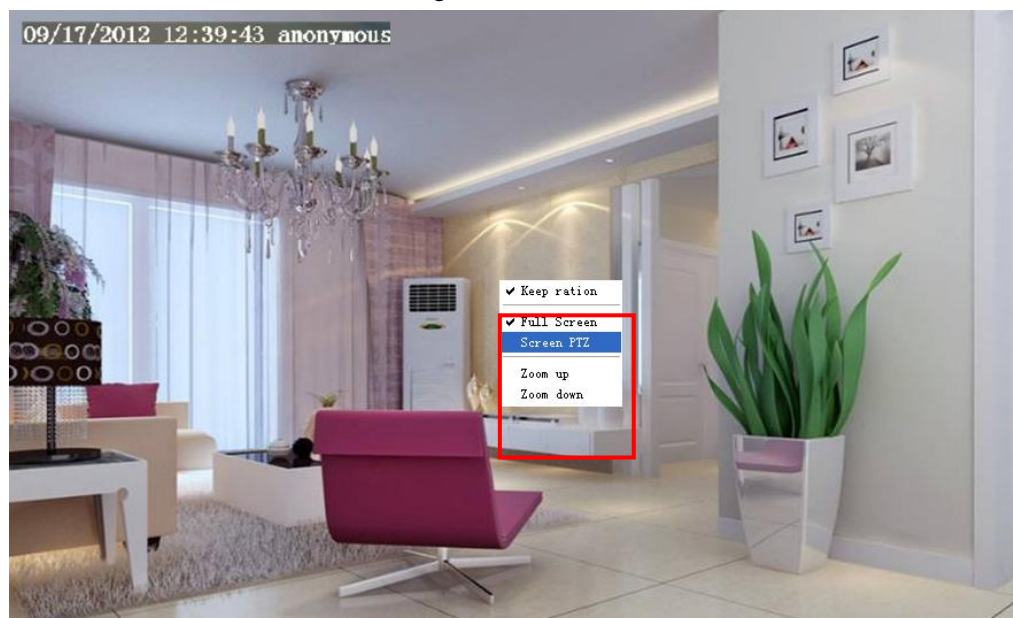

Click the **Screen PTZ** button and put the mouse on the screen to indicate the camera move direction you prefer, press the left mouse, the camera will move to the corresponding direction. Loosen the mouse and stop moving. Press Esc button or double click right mouse and cancel the function.

NOTE: For Mac OS, the plugin cannot support Onscreen Mouse Control, so you cannot allow to use it.

4 Advanced Camera Settings

Click the button “**Settings**”, goes to Administrator Control Panel to make advanced camera settings.

4.1 Setup Wizard

Please go to section 3.2 to find the way to set it.

4.2 Status

Status contains four columns: Device Information, Device Status, Session Status and Log, it will show you various information about your camera.

4.2.1 Device Information



Device Information	
Camera Model	FI9826P
Camera Name	FI9826P
Camera ID	C4D655397F42
Camera Time	2014/10/08 12:07:43
System Firmware Version	1.5.2.11
Application Firmware Version	2.21.1.127
Plug-In Version	3.0.0.6

Camera Model: The camera model NO.

Camera Name: The Device Name is a unique name that you can give to your device to help you identify it. Click **Basic Settings** and go to **Camera name** panel where you can change your camera name. The default device name is anonymous.

Camera ID: Display the wired MAC address of your camera.

Camera Time: The system time of the device. Click **Basic Settings** and go to **Camera time** panel and adjust the time.

System Firmware Version: Display the System Firmware version of your camera.

App Firmware Version: Display the application firmware version of your camera.

Plug-In Version: Display the plug-in version of your camera.

4.2.2 Device Status

On this page you can see device status such as Alarm status/ Record Status WIFI status and so on.

Device Status	
 Refresh	
Alarm Status	Disabled
Recording Status	Not Recording
SD Card Status	No SD card
SD Card Free Space	0KB
SD Card Total Space	0KB
NTP Status	Failed
DDNS Status	Disabled
UPnP Status	Disabled
WiFi Status	Not connected
IR LED Status	Off

4.2.3 Session Status

Session status will display who and which IP is visiting the camera now.

Session Status	
 Refresh	
Username	IP Address
1	192.168.1.101

4.2.4 Log

The log record shows who and which IP address accessed or logout the camera.

Pages:83				
Refresh				
<< 1 2 3 >> <input type="text"/> Go				
NO.	Time	User	IP	Log
1	2012-09-18 02:11:45			
2	2012-09-18 01:48:56			
3	2012-09-18 01:29:51	admin	192.168.1.102	Log out
4	2012-09-18 01:27:54	admin	218.17.160.187	Log out
5	2012-09-18 01:26:21	admin	192.168.1.100	Log out
6	2012-09-18 01:25:42	admin	218.17.160.187	Login
7	2012-09-18 01:25:15	admin	192.168.1.102	Login
8	2012-09-18 01:25:13	admin	192.168.1.102	Log out
9	2012-09-18 01:24:46	admin	192.168.1.100	Login
10	2012-09-18 01:21:44	admin	192.168.1.102	Login

Reboot the camera and clear the log records.

4.3 Basic Settings

This section allows you to configure your camera's Name, Time, Mail, User account and Multi-Device.

4.3.1 Camera Name

You can define a name for your camera here such as apple. Click Save to save your changes. The alias name cannot contain special characters.

Camera Name

Save Refresh

Camera Name	<input style="width: 90%;" type="text" value="R2 Plus"/> <p style="font-size: small; margin-top: 5px;">The maximum Device Name length is 20, support English, numbers, letters and symbols</p>
-------------	--

4.3.2 Camera Time

This section allows you to configure the settings of the internal system clocks for your camera.

Save Refresh	
Time Zone	(GMT) Greenwich mean time; London, Lisbon, (
Sync with NTP server <input checked="" type="checkbox"/>	
NTP Server	Auto
Device Time	2016-4-26 08 : 15 : 53 Sync with PC/Terminal
Date Format	YYYY-MM-DD
Time Format	24-hour
use DST <input checked="" type="checkbox"/>	
From	April first Sunday 2 : 00
To	October the last one Sunday 2 : 00
Ahead Of Time	0 Minute

Time Zone: Select the time zone for your region from the dropdown menu.

Sync with NTP server: Network Time Protocol will synchronize your camera with an Internet time server. Choose the one that is closest to your camera.

Sync with PC: Select this option to synchronize the date and time of the Network Camera with your computer.

Manually: The administrator can enter the date and time manually. Note select the date and time format.

use DST: Select the daylight saving time from the dropdown list.

Click **Save** button and submit your settings.

NOTE: If the power supply of camera is disconnect, you need set the camera's time again.

4.3.3 User Accounts

Here you can create users and set privilege, **visitor**, **operator** or **administrator**. The default user account is admin, with a blank password. You can enter the users accounts of visitor, operator and administrator Manually.

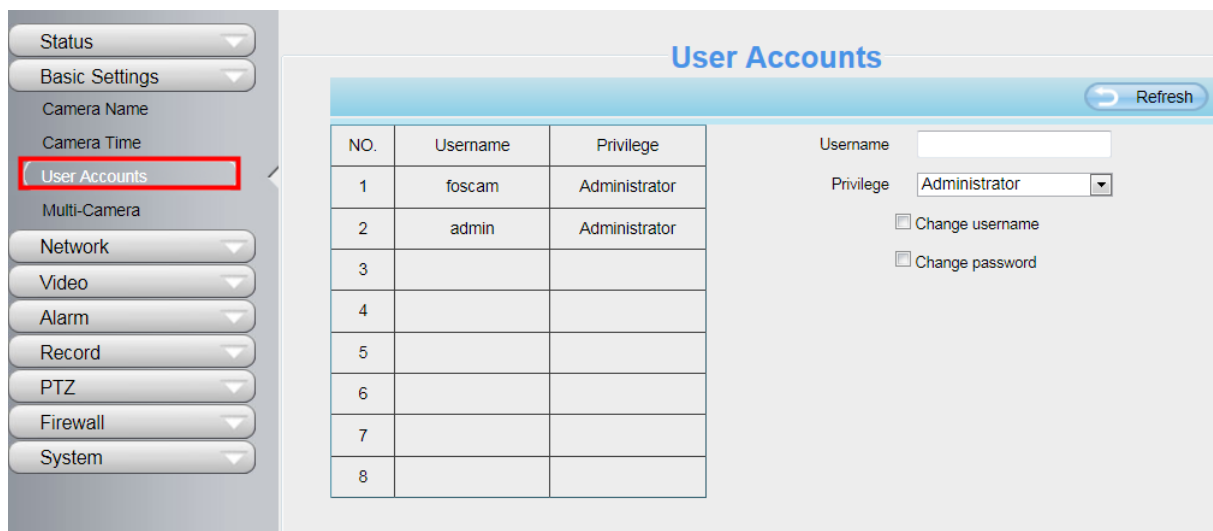

How to change the password?

Firstly, select the account which you want to change the password, then select “Change password”, enter the old password and the new password, lastly click modify to take effect.

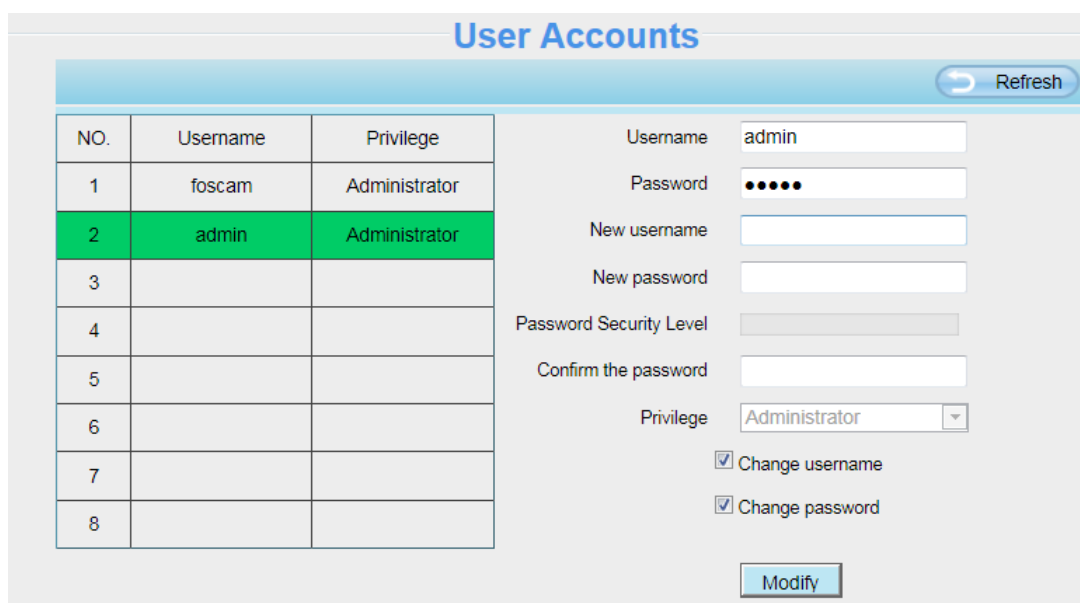

How to add account ?

Select one blank column, then enter the new user name, password and privilege, last click Add to take effect. You can see the new added account on the Account list.

User Accounts

Refresh

NO.	Username	Privilege
1	foscarn	Administrator
2	admin	Administrator
3		
4		
5		
6		
7		
8		

Username:
 Password:
 Password Security Level: Low security level.
 Confirm the password:
 Privilege:

Change username
 Change password

Add

User Accounts

Refresh

NO.	Username	Privilege
1	foscarn	Administrator
2	admin	Administrator
3	user	Administrator
4		
5		
6		
7		
8		

Username:
 Privilege:

Change username
 Change password

Delete

Delete: Select the account which you want to delete, then click Delete button to take effect.

NOTE: The default admin account cannot be deleted, but you can add other administrator users.

How to change the username ?

Firstly, select the account which you want to change the username, then select "Change username", enter the new password, lastly click modify to take effect.

User Accounts

NO.	Username	Privilege
1	1	Administrator
2	user	Administrator
3		
4		
5		
6		
7		
8		

Username:

New username:

Privilege:

Change username

Change password

4.3.4 Multi-Camera

If you want to view multi-surveillance screens on one window, you need to login one camera, and set it as the main device, and do Multi-Device Settings, add other cameras to the first one camera. Before you do multi-cams settings, you need to assign different port such as 81, 82, 83, 84, 85, 86, 87, 88 to the cameras if there is 8 cams installed.

The firmware within the camera can support a maximum of 9 devices monitoring all at the same time. This page you can both add FOSCAM MJPEG and H.264 series cameras to the first camera and view multi-surveillance screen on one window.

Add cameras in LAN

In Multi-Device Settings page, you can see all devices searched in LAN. The 1st Device is the default one. You can add more cameras in the list in LAN for monitoring. The camera's software supports up to 9 IP Cameras online simultaneously. Click The 2nd Device and click the item in the Device List in LAN, the Alias, Host and Http Port will be filled in the boxes below automatically. Enter the correct username and password then click Add. Add more cameras in the same way.

Multi-Camera

Cameras On LAN

The 1st Camera	This Camera
The 2nd Camera	None
Camera Model	H264
Camera Name	anonymo
Host	172.16.0.
HTTP Port	80
Media Port	80
Username	admin
Password	
	None
The 4th Camera	None

1 Click it, camera model, alias, host and HTTP Port will be filled in the following boxes automatically.

2 Enter the User name and password of the 2nd camera.

3 Click Add to take effect.

Camera Model: Our Company produces two series cameras: MJPEG and H.264. Here will show you which series the camera belongs to.

Refresh

Cameras On LAN	anonymous(192.168.11.193) F19821W for ebuyer (192.168.11.241) anonymous(192.168.11.203) anonymous(192.168.11.243)
The 1st Camera	This Camera
The 2nd Camera	anonymous(192.168.11.203)
The 3rd Camera	F19821W for ebuyer (192.168.11.241)
The 4th Camera	anonymous(192.168.11.203)
The 5th Camera	None
The 6th Camera	None
The 7th Camera	None
The 8th Camera	None
The 9th Camera	None

Note: If you want to access your camera remotely, make sure you are able to access it seperately through a browser.

Back to **Surveillance Windows**, and click Four Windows option, you will see four cameras you added.

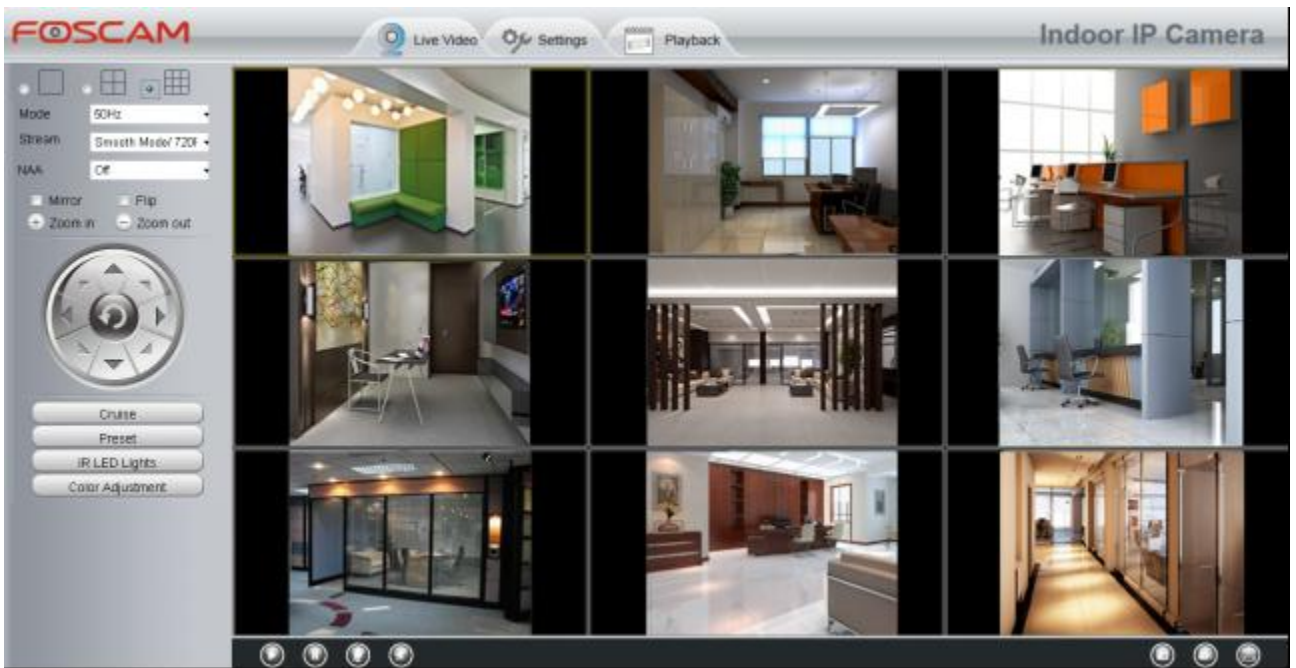
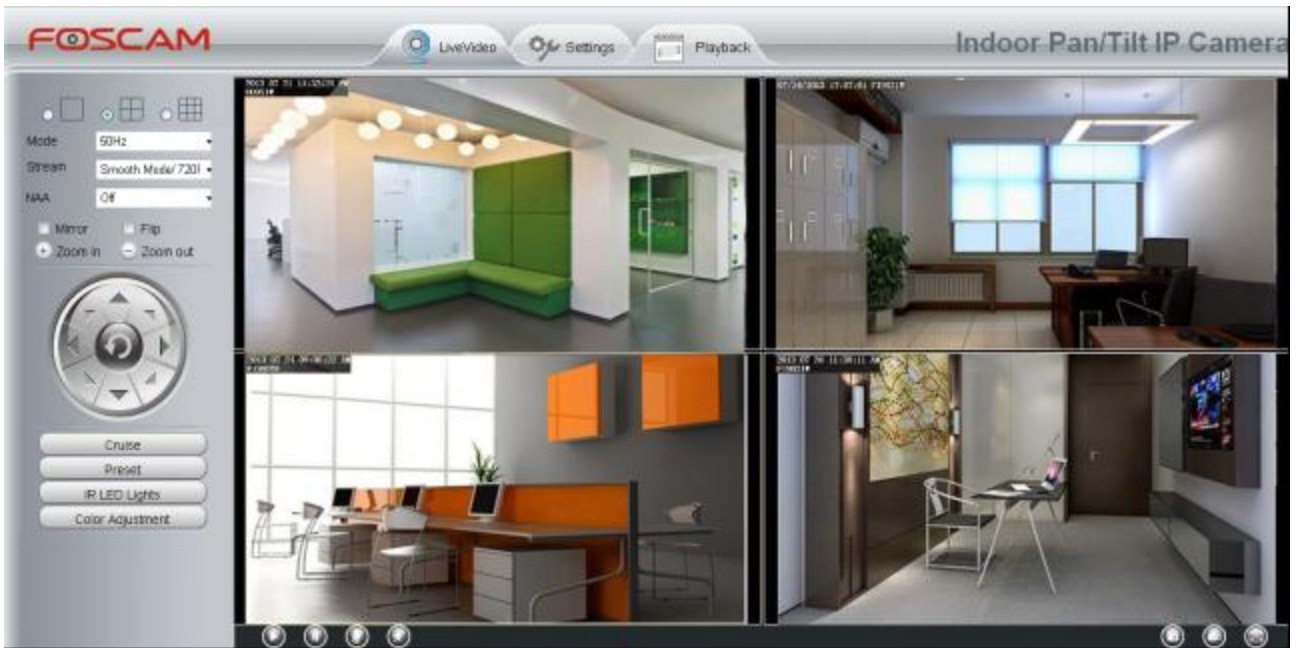

4.3.5 Voice Prompt

On this page, you can enable or disable voice prompt. Select “Yes” to enable or select “No” to disable.

Save
Refresh

Voice Prompt	<input style="width: 90%;" type="text" value="Yes"/>
--------------	--

4.4 Network

This section will allow you to configure your camera’s IP, Wireless Settings and Port.

4.4.1 IP Configuration

If you want to set a static IP for the camera, please go to **IP Configuration** page. Keep the camera in the same subnet of your router or computer.

Obtain IP From DHCP <input type="checkbox"/>	
IP Address	192.168.0.109
Subnet Mask	255.255.255.0
Gateway	192.168.0.1
Primary DNS Server	192.168.0.1
Secondary DNS Server	202.96.134.133

Note: Once you save your settings, the camera will restart.

Changing settings here is the same as using the Equipment Search Tool.

It is recommended that you use the subnet mask, gateway and DNS server from your locally attached PC. If you don't know the subnet mask, gateway and DNS server, you can check your computer's local area connection as follows:

Control Panel → **Network Connections** → **Local Area Connections** → **Choose Support** → **Details**

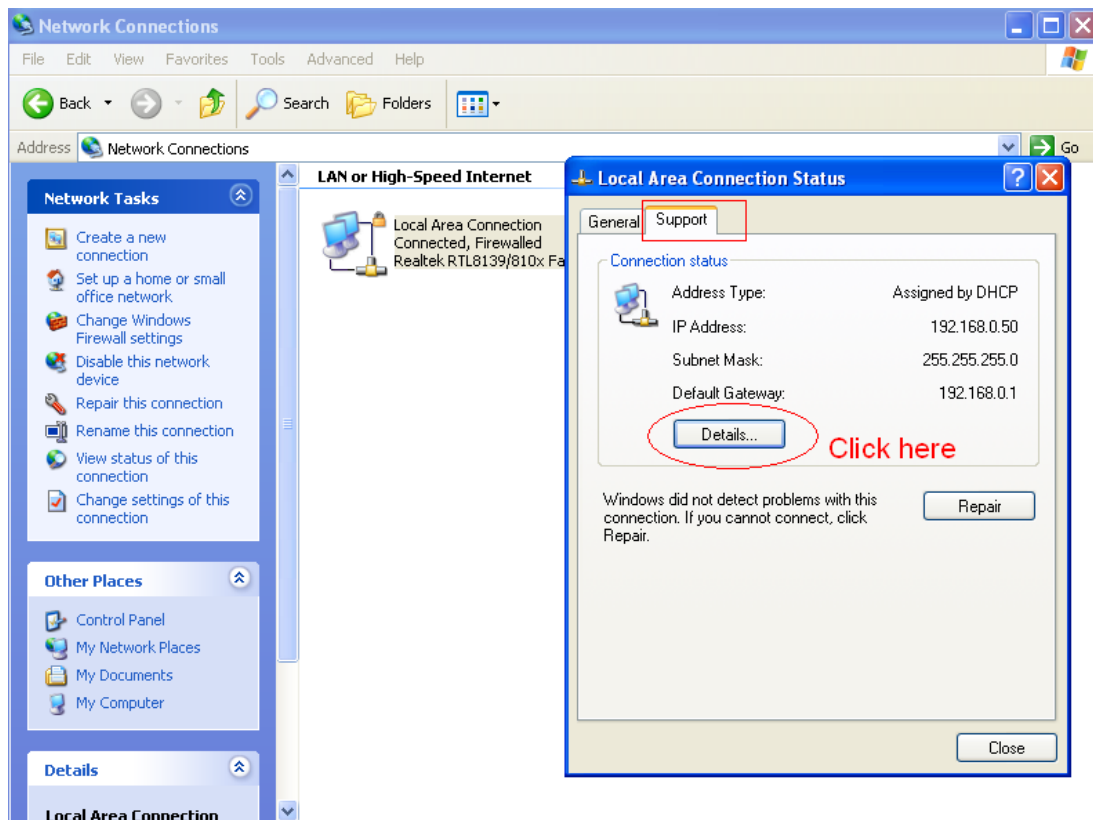

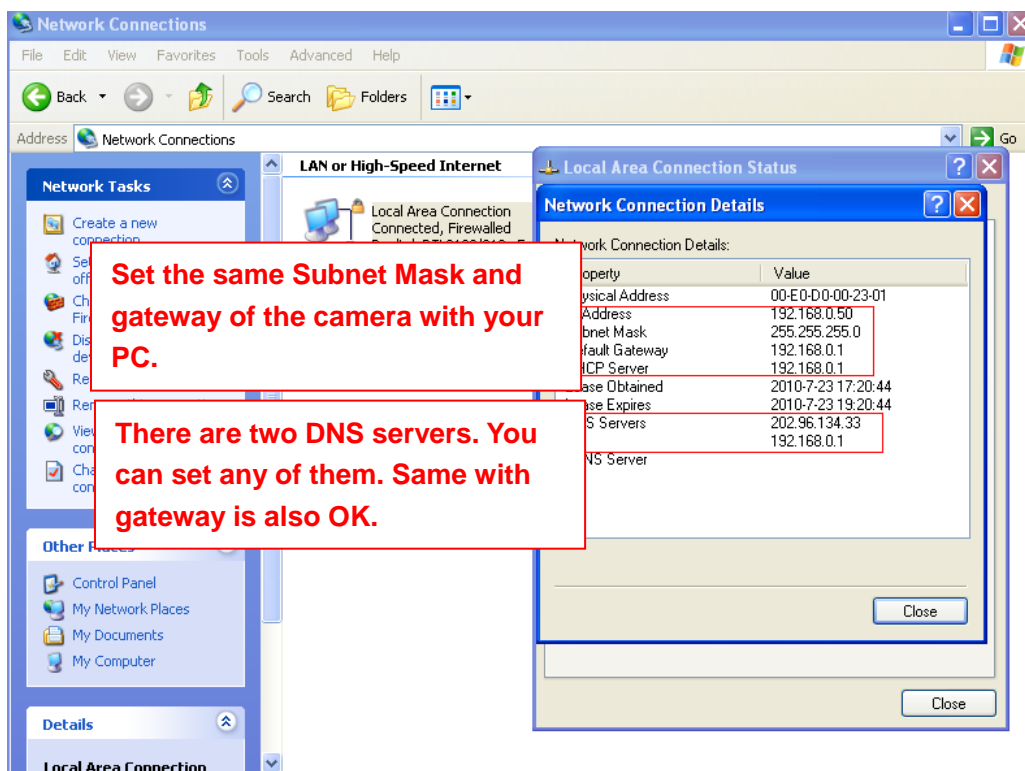

If you don't know the DNS server, you can use the same settings as the Default Gateway.

4.4.2 Wireless Settings

There are two ways of wireless connection: Manually configure the wireless connection and WPS.

Manually configure the wireless connection

Step 1: Choose "Settings" on the top of the camera interface, and go to the "Network" panel on the left side of the screen, then click "Wireless Settings."

Click the **Scan** button and the camera will detect all wireless networks around the area. It should also display your router in the list.



Step 2: Click the SSID (name of your router) in the list, the corresponding information related to your network, such as the name and the encryption, will be filled into the relevant fields automatically.

You will only need to fill in the password of your network. Make sure that the SSID, Encryption and the password you filled in are exactly the same for your router.

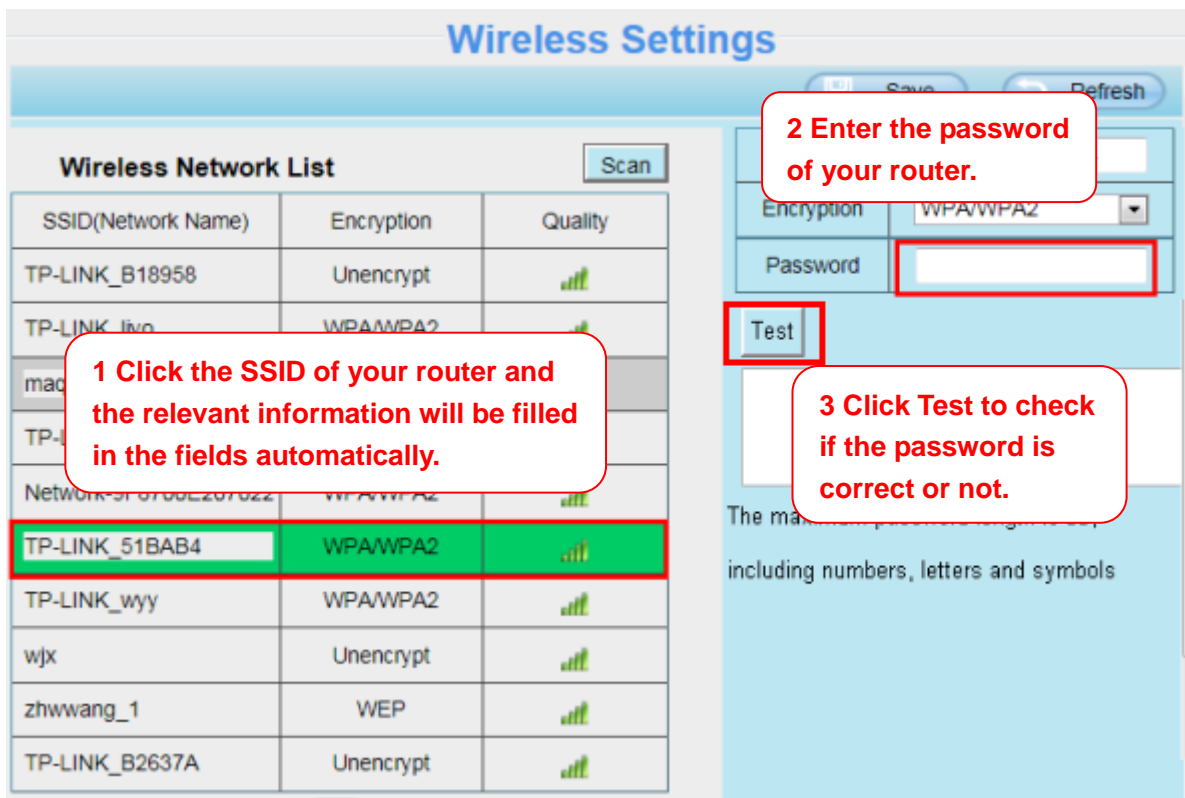

Step 3: Please click on the **Save** button after all settings have been entered and disconnect the network cable. Never shut down the power of the camera until the IP camera is able to connect to the wireless network.

The LAN IP address will disappear on the window of Equipment Search Tool when the camera is configuring a wireless connection. Wait about 1 minute, the camera should obtain a wireless connection, and the LAN IP of the camera will show again on the window of the Equipment Search Tool. The IP address may have changed after the camera receives a wireless connection; we recommend setting a static local IP address if this IP address changes by right clicking the camera in Equipment Search Tool, setting a static IP, and pushing OK.

Congratulations! You have set up the wireless connection of the camera successfully.

NOTE :

If you fail to make a wireless connection, please refer to your seller or contact us directly for assistance.

4.4.3 Port

This camera supports HTTP Port. HTTP Port is used to access the camera remotely. If you want to access the camera and view the video, the HTTP Port must both be configured correctly.

Port	
HTTP Port	88
HTTPS Port	443
ONVIF Port	888
RTSP port	554

HTTP port: By default, the HTTP is set to 88. Also, they can be assigned with another port number between 1 and 65535. But make sure they can not be conflict with other existing ports like 25, 21.

Another way to change the HTTP port NO.

Step 1: Open the Equipment Search Tool, select the camera you would like to change the port of, right click on the IP address, and click on "Network Configuration", this brings up the network configuration box as flowing figures.

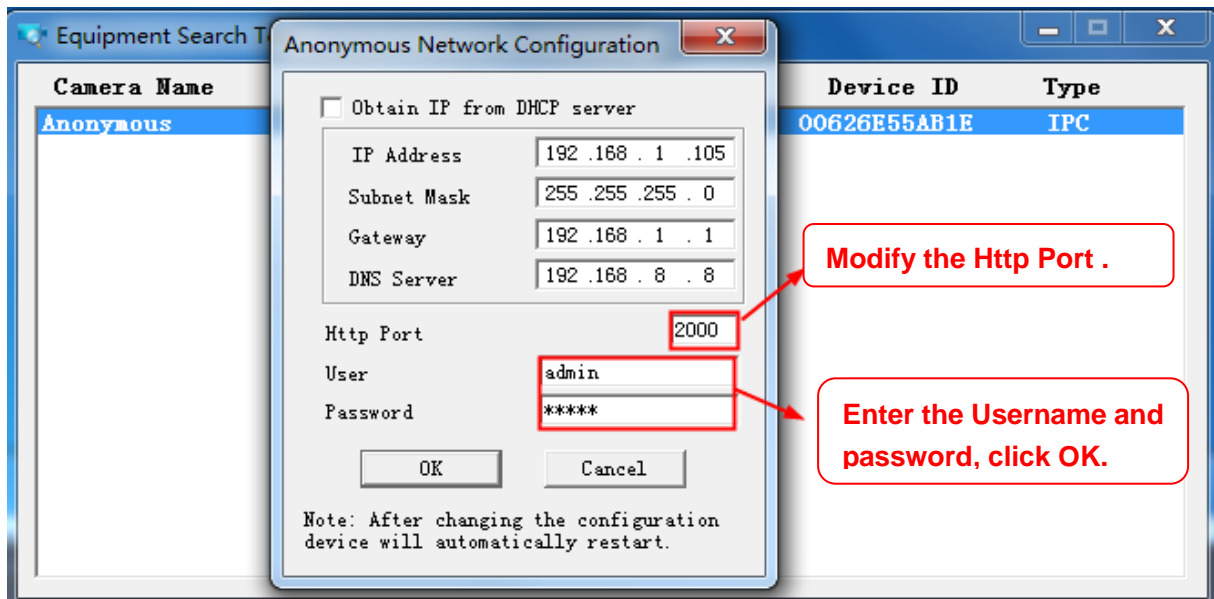
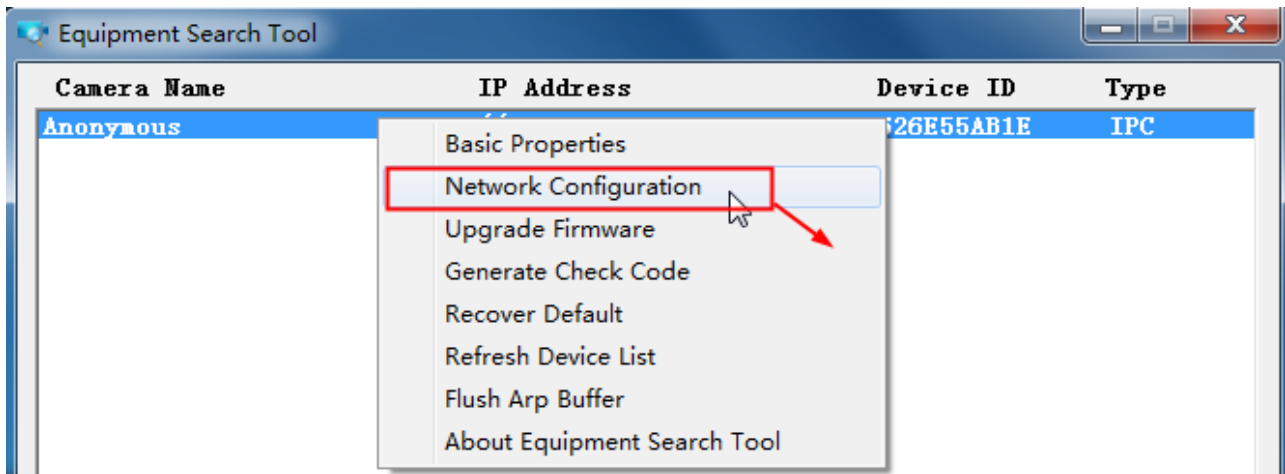

Step 2: Enter the username and password of the Administrator (default username is admin with a blank password), and click “OK” to apply changes.

Step 3: Wait around 10 seconds, you’ll see that the camera’s LAN IP address has changed. In our example it was changed to 2000, so we see http://192.168.1.105:2000 in Equipment Search Tool. Also, the LAN IP address is now fixed at a static IP address of http://192.168.1.105:2000. This IP address will not change even if the camera is powered off and back on, the camera will remain on this LAN IP address. This is very important that a static LAN IP address is set, or you may have problems later with remote access and seeing the camera remotely if the camera loses power and reconnects on a different LAN IP address. Make sure you set a static LAN IP address!

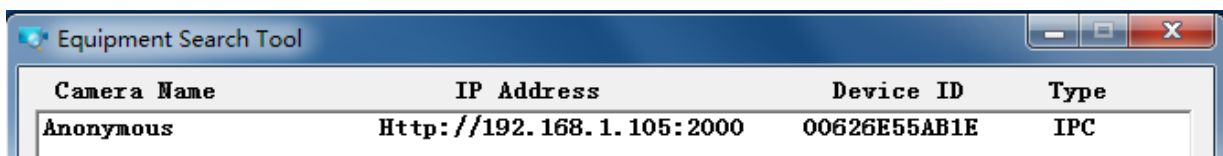

If the camera cannot be accessed, please make sure the port forwarding is succeed.

HTTPS port: The default port is 443. You can use the url to access the camera: **https:// IP + HTTPS port.**

ONVIF port: By default, the ONVIF port is set to 888. Also, they can be assigned with another port number between 1 and 65535(except 0 and 65534). But make sure they can not be conflict with other existing ports.

RTSP port: The default port is 443. Only some IP Cameras have RTSP port.

Note: The Onvif port and RTSP port are showed on Onvif page, you can enable or close the port. Please refer chapter 4.4.10.

4.4.4 Mail Settings

If you want the camera to send emails when motion has been detected, here Mail will need to be configured.

Enable <input checked="" type="checkbox"/>		5 Save Refresh	
SMTP Server	smtp.gmail.com	SMTP server address supports English, numbers and @ _ . -	
SMTP Port	25	1	
Transport Layer Security	STARTTLS	G-Mail only supports TLS at Port 465 and STARTTLS at Port 587 or 25. Hotmail only supports STARTTLS at Port 587 or 25.	
Need Authentication	Yes	2	
SMTP Username	test123@gmai.com	The maximum length of the user name is 63, support numbers, letters and symbols @ _ . \$ * -	
SMTP Password	The maximum password length is 32, does not support the character & =	
Sender E-mail	test123@gmai.com	3	Test 6
First Receiver	test@163.com	The maximum length of the receiver is 63, support numbers, letters and symbols @ _ . \$ * -	
Second Receiver	tset@hotmail.com	4	
Third Receiver			
Fourth Receiver			

1---- **SMTP Server/ Port /Transport Layer Security** Enter SMTP server for sender. **SMTP** port is usually set as 25. Some SMTP servers have their own port, such as 587 or 465, and Transport Layer Security usually is None. If you use Gmail, Transport Layer Security must be set to TLS or STARTTLS and SMTP Port must be set to 465 or 25 or 587, which port you choose should be decided by which Transport Layer Security you select.

2---- **SMTP Username/ password** ID account and password of the sender email address

3---- **Sender E-mail** Mailbox for sender must support SMTP

4---- **Receiver** Mailbox for receiver need not support SMTP,you can set 4 receivers

5---- **Save** Click Save to take effect

6---- **Test** Click Test to see if Mail has been successfully configured.

Click **Test** to see if Mail has been successfully configured.

The screenshot shows a configuration form for an email client. At the top right, there are 'Save' and 'Refresh' buttons. The form is titled 'Enable' with a checked checkbox. The fields are as follows:

SMTP Server	smtp.gmail.com <small>SMTP server address supports English, numbers and @ _ . -</small>
SMTP Port	25
Transport Layer Security	STARTTLS <small>G-Mail only supports TLS at Port 465 and STARTTLS at Port 587 or 25. Hotmail only supports STARTTLS at Port 587 or 25.</small>
Need Authentication	Yes
SMTP Username	test123@gmai.com <small>The maximum length of the user name is 63, support numbers, letters and symbols @ _ . \$ * -</small>
SMTP Password <small>The maximum password length is 32, does not support the character & =</small>
Sender E-mail	test123@gmai.com [Test] Success Test result.
First Receiver	test@163.com <small>The maximum length of the receiver is 63, support numbers, letters and symbols @ _ . \$ * -</small>
Second Receiver	tset@hotmail.com
Third Receiver	
Fourth Receiver	

If the test success, you can see the Success behind the Test, at the same time the receivers will receive a test mail.

If the test fails with one of the following errors after clicking **Test**, verify that the information you entered is correct and again select Test .

- 1) Cannot connect to the server
- 2) Network Error. Please try later
- 3) Server Error
- 4) Incorrect user or password
- 5) The sender is denied by the server. Maybe the server need to authenticate the user, please check it and try again
- 6) The receiver is denied by the server. Maybe because of the anti-spam privacy of the server
- 7) The message is denied by the server. Maybe because of the anti-spam privacy of the server
- 8) The server does not support the authentication mode used by the device

4.4.5 FTP Settings

If you want to upload record files and images to your FTP server, you can set **FTP Settings**.

Save Refresh	
FTP Server	ftp://192.168.8.150 Example:ftp://192.168.1.103/dir The maximum length of the address is 127, does not support the character & =
Port	21
FTP Mode	PORT
Username	yaocuixiang The maximum length of the user name is 63, support numbers, letters and symbols _ @ \$ * - . . # !
Password The maximum password length is 63, does not support the character & =
Test	Success

Figure a

Save Refresh	
FTP server	ftp://ftp.mgenseal.com example:ftp://192.168.1.103
Port	21
FTP Mode	PORT
User name	deotestge
Password
Test	Success

Figure b

FTP server: If your FTP server is located on the LAN, you can set as Figure a.

If you have an FTP server which you can access on the internet, you can set as Figure b.

Port: Default is port 21. If changed, external FTP client program must change the server connection port accordingly.

FTP Mode: Here supports two modes: PORT and PASV.

Username/password: The FTP account and password.

Click **Save** to take effect.

Click **Test** to see if FTP has been successfully configured.

4.4.6 P2P

Access the IP Camera by Smart Phone (Android or iOS operating system)

First of all, you must open the P2P function of the IP Camera at “**Settings --> Network --> P2P.**”

P2P	
UID	FLGTBW7YGBUV9NPMUR41
Enable P2P	<input checked="" type="checkbox"/>
P2P Port	29499

Foscam App named **Foscam** on App Store and Google Play for iOS and Android devices

NOTE:

If the QR code scanning is not successful, please input the UID on the bottom of the camera manually.

4.4.7 Onvif

On this page, you can enable the Onvif port and RTSP port. ONVIF(Open Network Video Interface Forum) is a standard for talking to Network Camera Devices and other similar security hardware.

ONVIF port: By default, the ONVIF port is set to 888. Also, they can be assigned with another port number between 1 and 65535(except 0 and 65534). But make sure they can not be conflict with other existing ports.

RTSP port: The default port is 554.

Onvif	
Enable	<input checked="" type="checkbox"/>
ONVIF Port	888
RTSP Port	554

4.5 Video

This section allows you to configure Video stream settings, On screen display and Snapshot settings.

4.5.1 Video Settings

There are two ways to set the stream video settings. They are main stream video settings and sub stream video settings.

Video Settings

Save
 Refresh

Main stream video settings

Enhanced Night Vision Definition

Stream Type	HD Mode
Resolution	720P
Bit Rate	2M
Frame Rate	30
Key Frame Interval	30
Variable bitrate	Yes

Sub stream video settings

Stream Type	HD Mode
Resolution	720P
Bit Rate	512K
Frame Rate	10
Key Frame Interval	30

Stream type: There are four types to identify different streams you have set.

Resolution: The camera supports multiple types. The higher the resolution is the clearer video will become. But the code flux will become larger too, and it will take up more bandwidth. (The maximum frame rate for each model is different.)

Bit Rate: Generally speaking, the larger the bit rate is, the clearer video will become. But the bit rate configuration should combine well with the network bandwidth. When the bandwidth is very narrow, and bit rate is large, that will lead to video can not play well.

Frame rate:Note that a larger frame size takes up more bandwidth. You should lower frame rate when the bandwidth is limited. Normally, when the frame rate above 15, you can achieve fluently video.The maximum frame rate for each model is different.

Key Frame Interval: The time between last key frame and next key frame. The shorter the duration, the more likely you will get a better video quality, but at the cost of higher network bandwidth consumption.

Variable Bitrate: The two options are Yes and NO. Select Yes the bit rate is variable, and the highest value isn't higher than Bit Rate Value (2Mbps). Select NO and the bit rate is constant with Bit Rate Value (2Mbps).

4.5.2 On Screen Display

This page is used to add timestamp and device name on the video.

OSD

Save Refresh

Display Timestamp	Yes
Display Camera Name	Yes

Display Time stamp

There are two options: Yes or NO. Select Yes and you can see the system date on the video.

Display Camera Name

There are two options: Yes or NO. Select Yes and you can see the device name on the video.

4.5.3 Privacy Zone

This page is used to set some mask as privacy zone on the video.

Save Refresh

Allow Privacy Zone	Yes
	Set Privacy Zone

Allow On Screen Display Mask

There are two options: Yes or NO. Select yes and draw up to four mask areas on the video, the mask area will be black on the video.

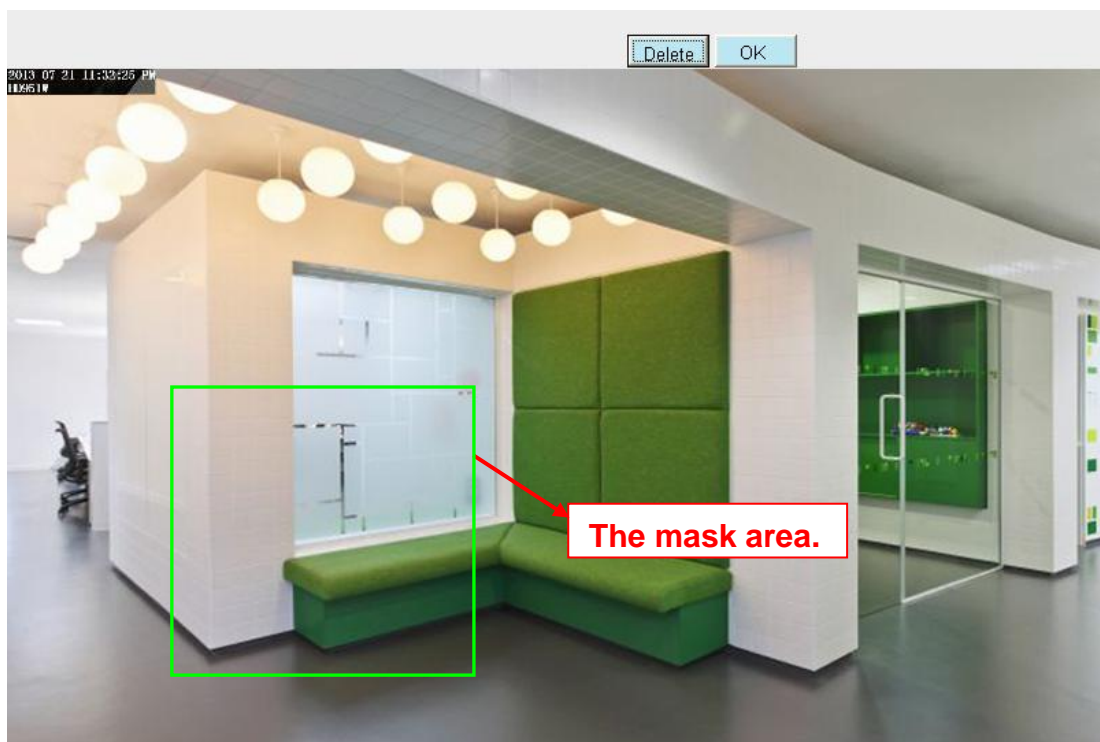

Click **OK** button and return to the OSD page, click Save to take effect.

Back to the surveillance window, you can see the mask area as the following picture:

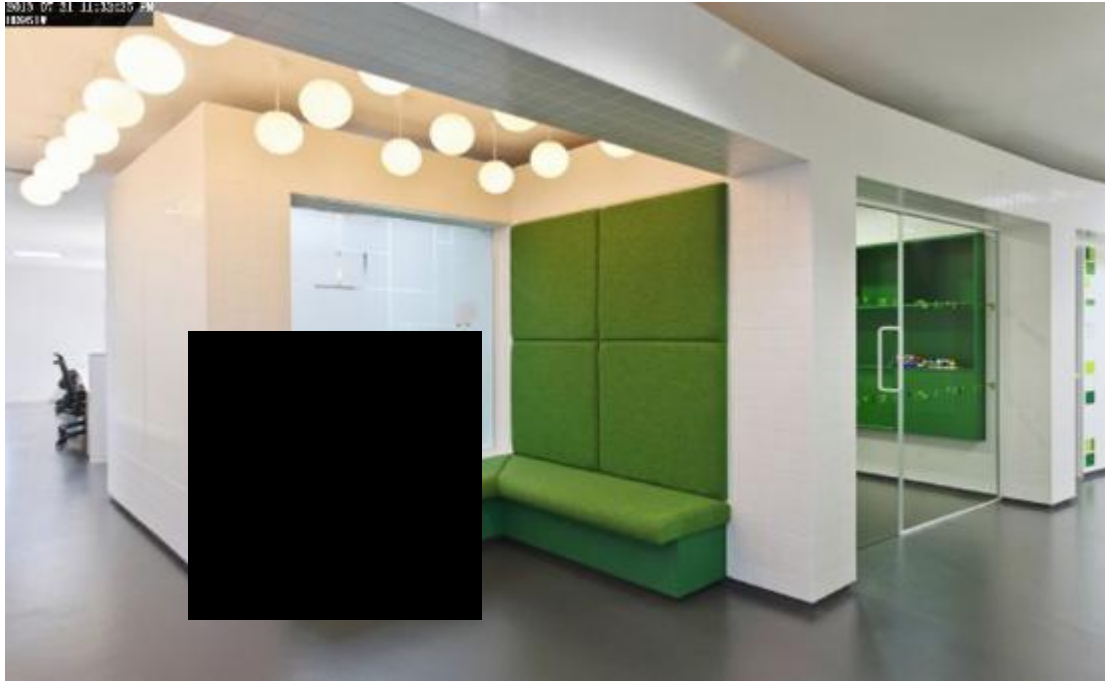

4.5.4 Snapshot Settings

On this page you can set the snapshot pictures' image quality and the storage path.

Save Refresh

Manual snap Quality	Medium
Pictures Save To	None

Enable timing to capture

Capture interval	10	(5-65535s)
------------------	----	------------

⌚ Schedule

All	00	01	02	03	04	05	06	07	08	09	10	11	12	13	14	15	16	17	18	19	20	21	22	23
MON																								
TUE																								
WED																								
THU																								
FRI																								
SAT																								
SUN																								

Manual snap Quality: Low, Middle and High. The higher the quality, the picture will be clearer.

Pictures Save To: FTP or SD card. If you have done FTP and Alarm settings, when alarming, the camera will snap pictures to the FTP or SD card automatically.

If you select the FTP, you can set the file name which the picture save to. For example: file name is "NAME", the snapshot picture is "NAME_20150605-180000.jpg" .

Enable timing to capture

To enable capture interval, follow the steps below:

1 Select **Enable Motion detection**

2 Capture interval:The interval time between two captures.

3 Select the capture time

- Capture anytime

Click the black button up the MON, you will see all time range turn red. When something moving in the detection area at anytime, the camera will capture.

- Specify an capture schedule

Click the week day words, the corresponding column will be selected. For example, click TUE, the all column of TUE turns to red, that means during Tuesday whole day, the camera will capture.

- Press the left mouse and drag it on the time boxes, you can select the serial area,

4 Click Save button to take effect.

4.5.5 IR LED Schedule

On this page you can set the schedule time for switching IR LED lights. When parameter Mode is set to the **Schedule** on the **Live Video** window, at these schedule time, the IR LED lights will be turned off.

The screenshot shows a web interface titled "IR LED Schedule". At the top right, there are two buttons: "Save" and "Refresh". Below the title, the text "IR LED Schedule" is displayed. The main area contains a light blue button labeled "Turn the IR LED off". To the right of this button, there is a time selection field with "From" and "To" labels. The "From" field is set to "08:00" and the "To" field is set to "18:00". Below these fields is an "Add" button.

4.6 Detector

4.6.1 Motion Detection

IP Camera supports **Motion Detection Alarm**, when the motion has been detected, the IP Camera will make a alarm.

Step 1: Enable Motion detection

Step 2: Sensitivity---- It supports five modes: Lowest, Lower, Low, Medium and High. The higher the sensitivity, the camera will be more easily alarmed. Select one motion sensitivity.

Step 3: Trigger interval--- The interval time between two motion detection.

Step 4: There are some alarm indicators:

A Camera Sound and PC Sound

If the camera has connected with a speaker or other audio output device, if you select Camera Sound or PC Sound, when the motion has been detected, the people around the camera will hear beep alarm sound.

B Send E-mail

If you want to receive alarm emails when motion is detected, you must select Send E-mail and set Mail Settings first.

C Take Snapshot

If you select this checkbox, when the motion has been detected, the camera will snap the live view window as a still picture and load it to the FTP. Make sure you have set FTP and set FTP as the storage path in Video->Snapshot settings panel.

Capture interval: The interval time between two pictures.

D Recording

If you select this checkbox, when the motion has been detected, the camera will record automatically and store the record files to the SD Card. Make sure the camera has inserted SD card and you have set the SD card as the Alarm record files storage path, please go to **Record—> Storage location** page to verify this settings.

The default alarm record time is 30s and pre-alarm record time is 5s, please go to **Record—> Alarm Record** page and change the alarm time settings.

E Push message to the phone

If you select this checkbox, when the motion has been detected, the camera will push the message to the phone which has been connected the camera.

Step 5: Set detect area

Click set detect area and it pop up a window, then you can draw the detection area. Click **OK** button after settings. When something moving in the detection area, the camera will alarm.

Step 6: Alarm Schedule

① Alarm anytime when motion is detected

Click the black button up the MON, you will see all time range turn red. When something moving in the detection area at anytime, the camera will alarm.

All	00	01	02	03	04	05	06	07	08	09	10	11	12	13	14	15	16	17	18	19	20	21	22	23
MON																								
TUE																								
WED																								
THU																								
FRI																								
SAT																								
SUN																								

Scheduled recording will stop while alarm recording begins and go on automatically after it ends.

② Specify an alarm schedule

Click the week day words, the corresponding column will be selected. For example, click TUE, the all column of TUE turns to red, that means during Tuesday whole day, when something moving in the detection area, the camera will alarm.

Schedule																								
All	00	01	02	03	04	05	06	07	08	09	10	11	12	13	14	15	16	17	18	19	20	21	22	23
MON																								
TUE																								
WED																								
THU																								
FRI																								
SAT																								
SUN																								

③ Press the left mouse and drag it on the time boxes, you can select the serial area.

Schedule																								
All	00	01	02	03	04	05	06	07	08	09	10	11	12	13	14	15	16	17	18	19	20	21	22	23
MON																								
TUE																								
WED																								
THU																								
FRI																								
SAT																								
SUN																								

Step 7: Click Save button to take effect.

When the motion has been detected during the detection time in the detection area, the camera will alarm and adopt the corresponding alarm indicators.

NOTE: You must set the detection area and detection schedule, or else there is no alarm anywhere and anytime.

4.6.2 Sound Detection

Some models support Sound alarm.

When the ambient sound over a certain decibel ,the sound alarm will be triggered.

Sound Detection

Enable

Sensitivity	<input type="text" value="Low"/>
Triggered Interval	<input type="text" value="15s"/>
Action	<input type="checkbox"/> Camera Sound <input type="checkbox"/> PC Sound
	<input checked="" type="checkbox"/> Send E-mail
	<input checked="" type="checkbox"/> Take Snapshot <input type="text" value="2s"/> Time Interval
	Please set the capture storage location in advance.(Video -> Snapshot Settings)
	<input checked="" type="checkbox"/> Recording Please set the video storage location in advance.(Record -> Storage Location)
	<input checked="" type="checkbox"/> Push message to the phone

Schedule

	00	01	02	03	04	05	06	07	08	09	10	11	12	13	14	15	16	17	18	19	20	21	22	23
All																								
MON																								
TUE																								

If the Sensitivity is set to “High”, the camera will detect the sound whose more than 55db.
 If the Sensitivity is set to “Medium”, the camera will detect the sound whose more than 65db.
 If the Sensitivity is set to “Low”, the camera will detect the sound whose more than 75db.
 If the Sensitivity is set to “Lower”, the camera will detect the sound whose more than 85db.
 If the Sensitivity is set to “Lowest”, the camera will detect the sound whose more than 95db.

4.7 Record

This section will allow you to change the record files storage path and the record time.

4.7.1 Storage Location

On this page you can change the alarm and manually recording storage path.

Storage Location

Recording Location	None	
Local Recording Location	c:\IPCamRecord	<input type="button" value="Browse"/> <input type="button" value="Enter the local folder"/>

Recording Location is used for alarm recordings and schedule recordings.

The local recording must be stored in local storage. The default Windows storage location is "c:\IPCamRecord". The default Mac OS storage location is "/IPCamRecord". If you modify the path on other cameras, this default storage location will be modified accordingly.

Alarm Recording Location : SD card, FTP.

Check "SD card" : The video will be saved in SD card. **Make sure the camera has been inserted the SD card.** On this page, you can see the available space of the SD card.

Check "FTP" : The video will be saved in FTP. Please refer to "FTP settings."

Local Recording Location: For Windows OS, the manual recording path is C:/ IPCamRecord, you can change another one. For MAC OS, the manual recording path is: / IPCamRecord.

Enter the local folder :Click here,you can enter the local folder.

4.7.2 Alarm Recording

Alarm Recording

Enable Pre-Record

Pre-recorded Time	2s
Alarm Recording Time	30s

4.7.3 Local Alarm Recording

This page you can enable the local alarm record and Local Alarm record time.

Local Alarm Recording

Enable Local Alarm Recording

Local Alarm Recording Time	30s
----------------------------	-----

4.7.4 Schedule Recording

When the video is selected as FTP, the device supports scheduled recording.



The screenshot shows the 'Storage Location' configuration page. At the top, there are 'Save' and 'Refresh' buttons. Below, the 'Recording Location' dropdown menu is set to 'FTP' and is highlighted with a red box. The 'Local Recording Location' is set to 'c:\IPCamRecord' with a 'Browse' button next to it.

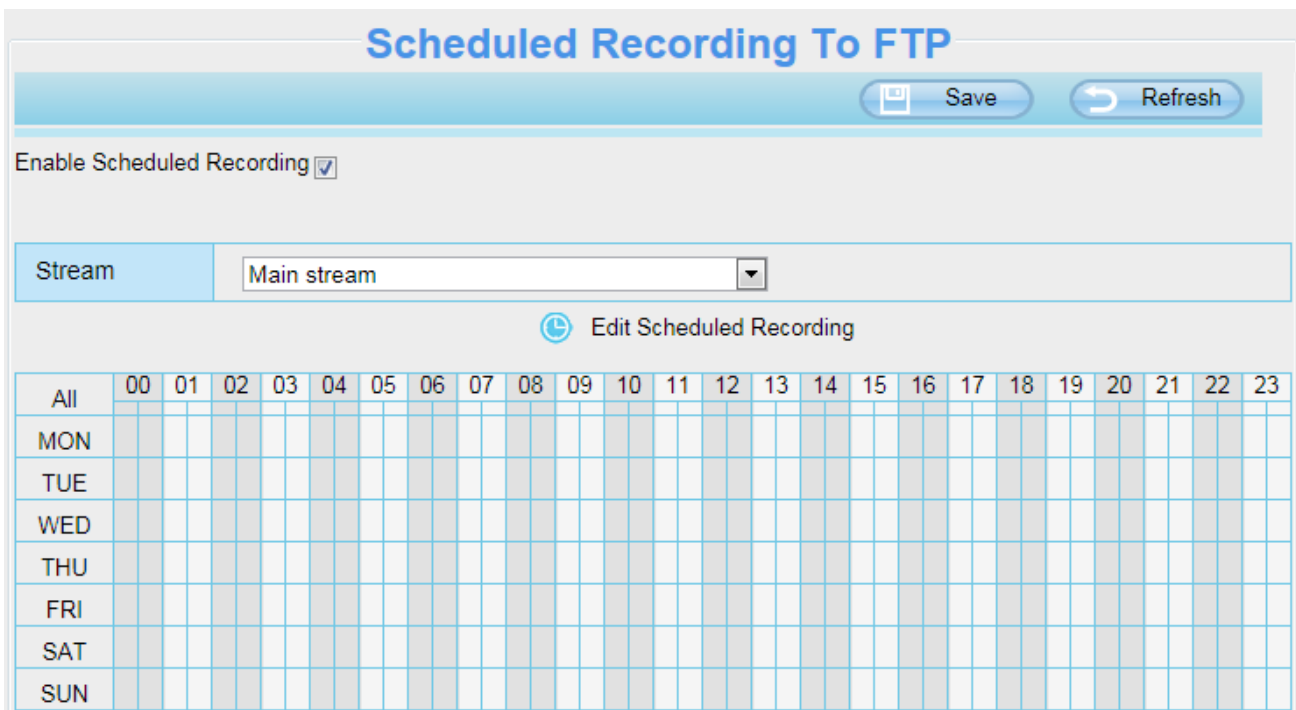

The screenshot shows the 'Scheduled Recording To FTP' configuration page. It features 'Save' and 'Refresh' buttons at the top. A checkbox labeled 'Enable Scheduled Recording' is checked. Below, the 'Stream' dropdown menu is set to 'Main stream'. A clock icon and the text 'Edit Scheduled Recording' are positioned above a calendar grid. The grid has rows for days of the week (All, MON, TUE, WED, THU, FRI, SAT, SUN) and columns for hours (00 to 23). The 'All' row is highlighted in grey.

When the video is selected as SD card, the device supports pumping frame recording.

When the parameter **Recording Location** is set **SD Card** on the **Storage Location** page, you can configure parameters as shown in follow figure.

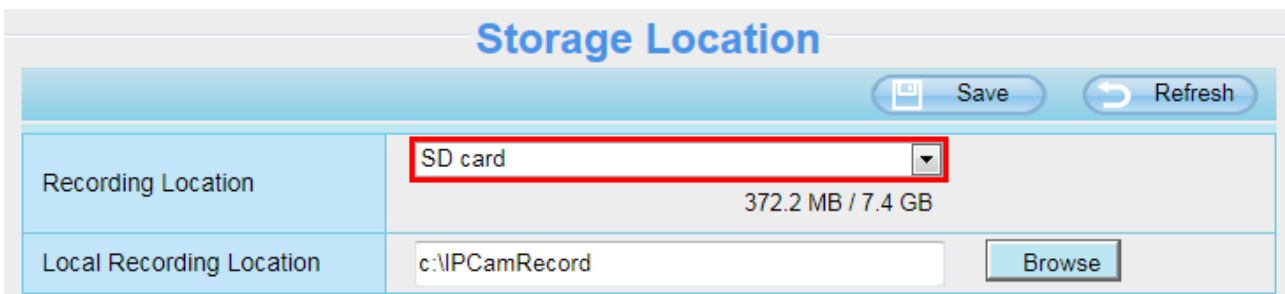

The screenshot shows the 'Storage Location' configuration page with 'SD card' selected in the 'Recording Location' dropdown menu, which is highlighted with a red box. Below the dropdown, the text '372.2 MB / 7.4 GB' is displayed. The 'Local Recording Location' is set to 'c:\IPCamRecord' with a 'Browse' button next to it.

Scheduled Recording To SD Card

Save Refresh

Enable Scheduled Recording

Enable Long-time recording No

Record frame 30

Record full strategy Cover

Audio Record No

Stream Main stream

[Edit Scheduled Recording](#)

All	00	01	02	03	04	05	06	07	08	09	10	11	12	13	14	15	16	17	18	19	20	21	22	23
MON																								
TUE																								
WED																								
THU																								
FRI																								

Record frame: There are six frame selections, such as 1/30, 4/30, 8/30, 15/30, 24/30, 30/30. Recommended default is 4/30. The greater the Frame rate is, the sharper picture quality is, and the greater of storage space is, the shorter the storage time is.

Record full strategy: When the SD card is full, you can choose to cover the previous recording, or stop recording.

Audio Record: You can choose "yes" or "no".

NOTES:

- Scheduled recording only supports video saved to the SD card or FTP server.
- The schedule recording will stop while alarm recording is beginning, and it will continue automatically after alarm recording end.
- You can refer to "alarm schedule." in "Alarm" about editing the time of recording Schedule.

4.7.5 SD Card Management

This camera supports SD Card and the max size of SD card must be under 128G.

When you plug in the SD card during the camera work process, please reboot the camera again, or else the SD Card may be cannot work well.

SD Card Management

SD Card Status	No SD card
SD Card Free Space	0KB
SD Card Total Space	0KB

Note: SD card management is only effective when access the IPC in LAN

The default storage path of alarm record files is SD card, when the available size of SD card is less than 256M, the old record files will be deleted automatically.

4.8 PTZ

This page will allow you to change the pan/tilt speed and do cruise tracks settings.

4.8.1 Pan & Tilt Speed

There are five Pt speed types: very fast, fast, normal, slow and very slowly. Select the desired PTZ speed type and click save button.

There are three zoom speed types: fast, normal, slow.

4.8.2 Cruise Settings

This section explains how to add/ delete/ alter one cruise track.

Cruise Settings

Refresh

Cruise Mode	Cruise time	
Cruise time	15 Minute	
Save		

Cruise Tracks	Vertical	Add	Delete	Save
---------------	----------	-----	--------	------

Preset point

- TopMost
- BottomMost
- LeftMost
- RightMost

Cruise track

Preset point	Dwell time
TopMost	0 Sec
BottomMost	0 Sec

Add

Delete

Up

Down

Setting the Cruise Mode

There are two cruise mode: Cruise time and Cruise Loops.

Cruise time: Select **Cruise time** from **Cruise Mode** drop-down, then you can set the **Cruise time** of the camera.

Cruise Loops: Select **Cruise Loops** from **Cruise Mode** drop-down, you can set the **Cruise Loops** of the camera.

Click **Save** to take effect.

Cruise Mode	Cruise time
Cruise time	15 Minute
Save	

Cruise Mode	Cruise Loops
Cruise Loops	loops
Save	

Manage the Cruise Track

There are two default cruise tracks: Vertical and Horizontal.

Vertical: The camera will rotate from up to down

Horizontal: The camera will rotate from left to right.

Add: Add one cruise track, then click save button.

Delete: Select one cruise track and delete it.

Save: After you modify the **Dwell time**, you should click **Save** button to take effect.

Example

How to do add cruise tracks ?

Firstly, Click Add button and enter a descriptive name to identify the cruise track.

Secondly: On the lower left of the page, you can see all preset points you have added. Select one preset point and click Add button, you can see the preset point has been added to the cruise track on the cruise track page. You need to add two or more preset points to the cruise track.

The screenshot shows the 'Cruise Settings' interface. At the top, there is a 'Refresh' button. Below it, there are two dropdown menus: 'Cruise Mode' set to 'Cruise time' and 'Cruise time' set to '15 Minute'. A 'Save' button is located below these. The 'Cruise Tracks' section has a text input field containing 'test', with 'OK' and 'Cancel' buttons to its right. A note below the input field states: 'The maximum length of name is 20, supports English, numbers, letters and symbols _ -'. Below this, there are two panels. The left panel, titled 'Preset point', lists 'TopMost', 'BottomMost', 'LeftMost', and 'RightMost'. The 'LeftMost' item is highlighted in green. A red box with the text '1 Select one preset point.' points to this item. The right panel, titled 'Cruise track', shows a table with two columns: 'Preset point' and 'Dwell time'. The table contains two rows: 'BottomMost' with '1 Sec' and 'LeftMost' with '2 Sec'. The 'LeftMost' row is highlighted in green. A red box with the text '2 Click Add button.' points to the 'Add' button between the two panels. Another red box with the text 'The new added track name.' points to the 'test' input field. A third red box with the text 'Here you can see the preset point has been added to one track. And you can set the stay time.' points to the 'LeftMost' row in the table.

Thirdly: Click **OK** button and the cruise track will take effect.

You can add other cruise track as the same method.

For example: I have added three preset points to the "track 1", that means : When I select the "track 1" on the surveillance window, the camera moves as the following track: upright then Right Most last down left.

You can add preset on the left of the surveillance window.

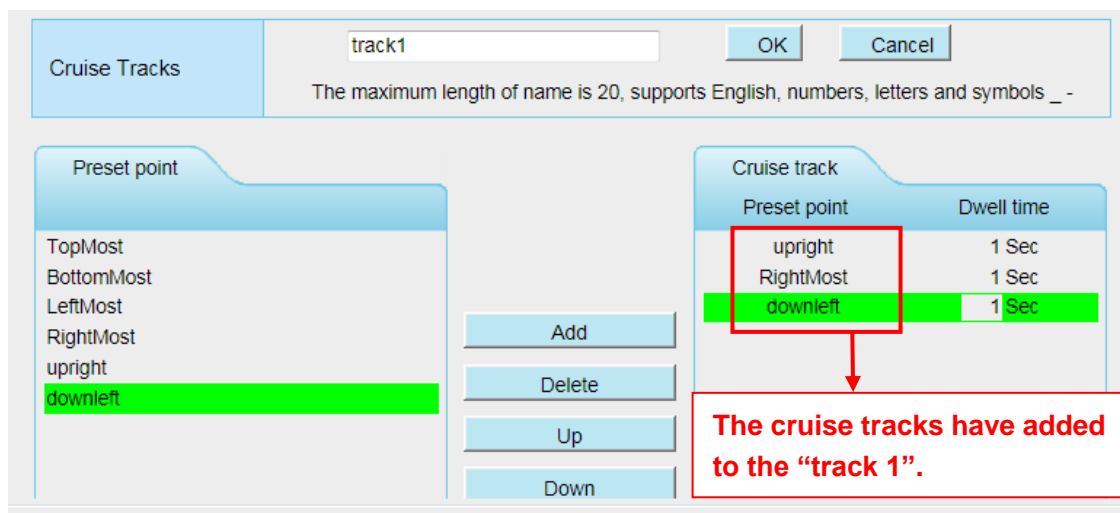
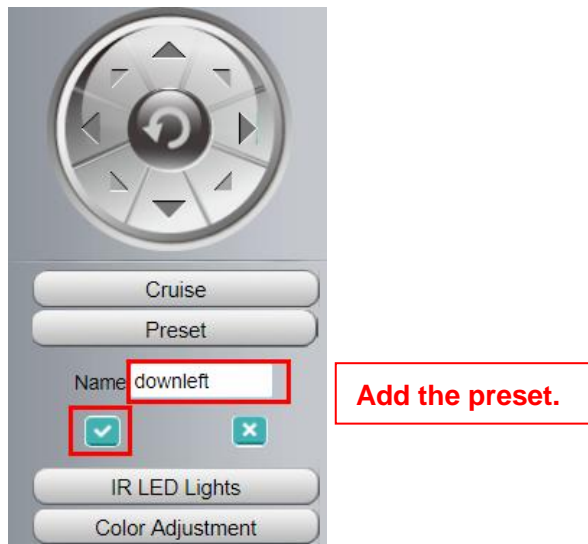

After add the cruise track, back to the surveillance window, click Cruise, here you can see all cruise tracks you have added.

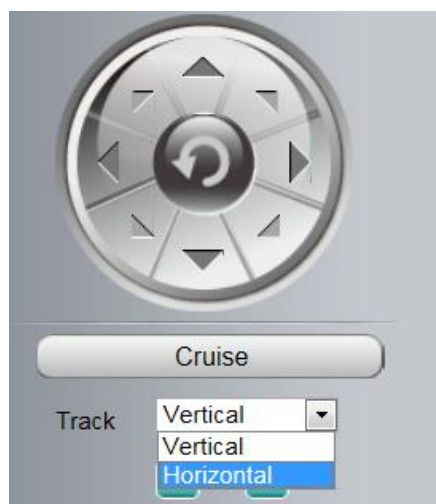

There are other buttons between the Preset points and Cruise track, you can use these buttons to adjust

the order of preset points or add/delete one preset points in one cruise track.

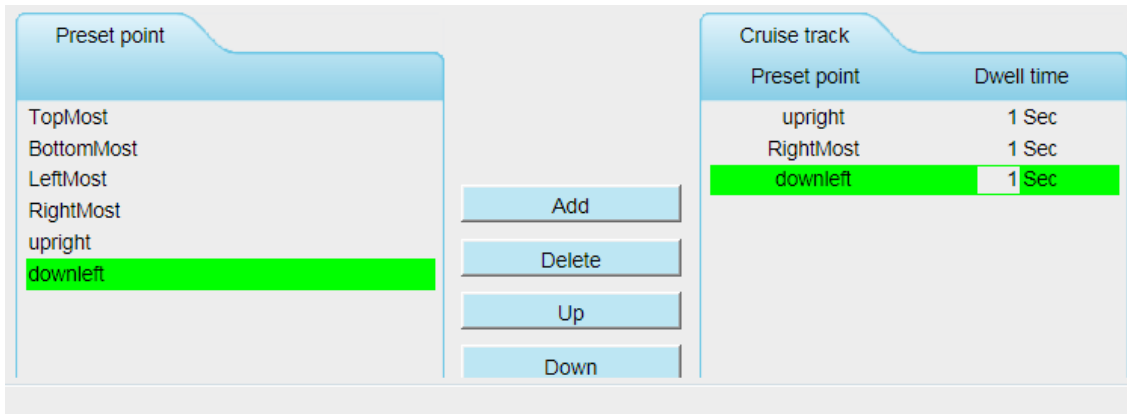

Add: Select one preset points and add it to the selected cruise track.

Delete: Select one preset points you have added to one cruise track, click delete.

Move up/ down: Select one cruise track, adjust the order of preset points in one cruise track.

Attention:

Considering the life time and thermal issue of the motor, it's not recommend to do long-time cruise.

4.8.3 Start-Up Options

Here section will allow you to set the stop position after the camera reboots.

It supports three modes: No self test, Goto home position and Goto preset point.

No self test: When rebooting, the camera will not pan / tilt.

Goto home position: When rebooting, the camera will pa Providing Central Management Software to manage or monitor multi-cameras n / tilt and stops at center.

Go to Preset point: Select one preset position and save it. When rebooting, the camera will pan/ tilt and stops at the preset position you have set.

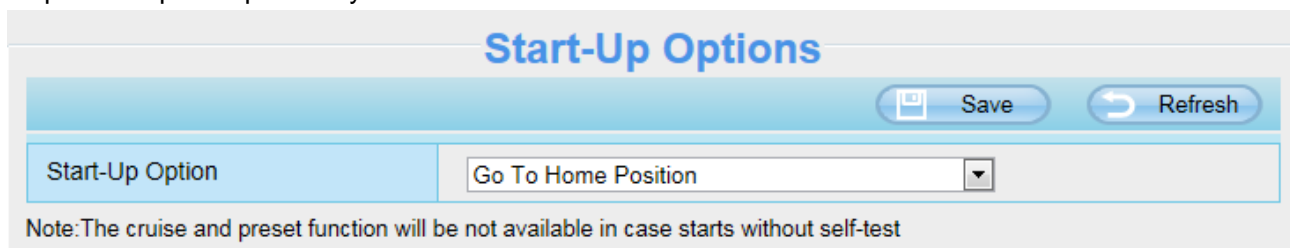

4.9 Firewall

This section explains how to control the access permission by checking the client PC's IP addresses. It is composed of the following columns: **Block access from these IP addresses** and **Only allow access from these IP addresses**.

Save Refresh	
Enable Firewall <input checked="" type="checkbox"/>	
IP Filtering	Block access from these IP addresses Block access from these IP addresses Only allow access from these IP addresses
IP Address #1	<input type="text"/>
IP Address #2	<input type="text"/>
IP Address #3	<input type="text"/>
IP Address #4	<input type="text"/>
IP Address #5	<input type="text"/>
IP Address #6	<input type="text"/>
IP Address #7	<input type="text"/>
IP Address #8	<input type="text"/>

Enable firewall, If you select Only allow access from these IP addresses and fill in 8 IP addresses at most, only those clients whose IP addresses listed in the **Only allow access from these IP addresses** can access the Network Camera. If you select **Block access from these IP addresses**, only those clients whose IP addresses are in the IP list cannot access the Network Camera. Click **Save** to take effect.

4.10 System

In this panel, you can backup/restore your camera settings, upgrade the firmware to the latest version, restore the camera to default settings and reboot the device.

4.10.1 Back-up& Restore

Click **Backup** to save all the parameters you have set. These parameters will be stored in a bin file for future use.

Click Browse and select the parameters file you have stored, then click Submit to restore the restore the parameters.

Backup is used to save your current settings. It is recommended to backup your configuration before modifying or upgrading firmware.

Backup

Settings can be restored by uploading the backup file.

Path:

Browse...

Submit

Note:

1. All current settings will be lost when importing a configuration file. If an incorrect file is loaded, the camera may stop working correctly.
2. Keep the power on during this process, or you may damage your camera. Your camera will reboot automatically once restoration is completed.

4.10.2 System Upgrade

Click “Download the latest firmware”, you will see the following screen. And click “save” to save the firmware on your computer locally.

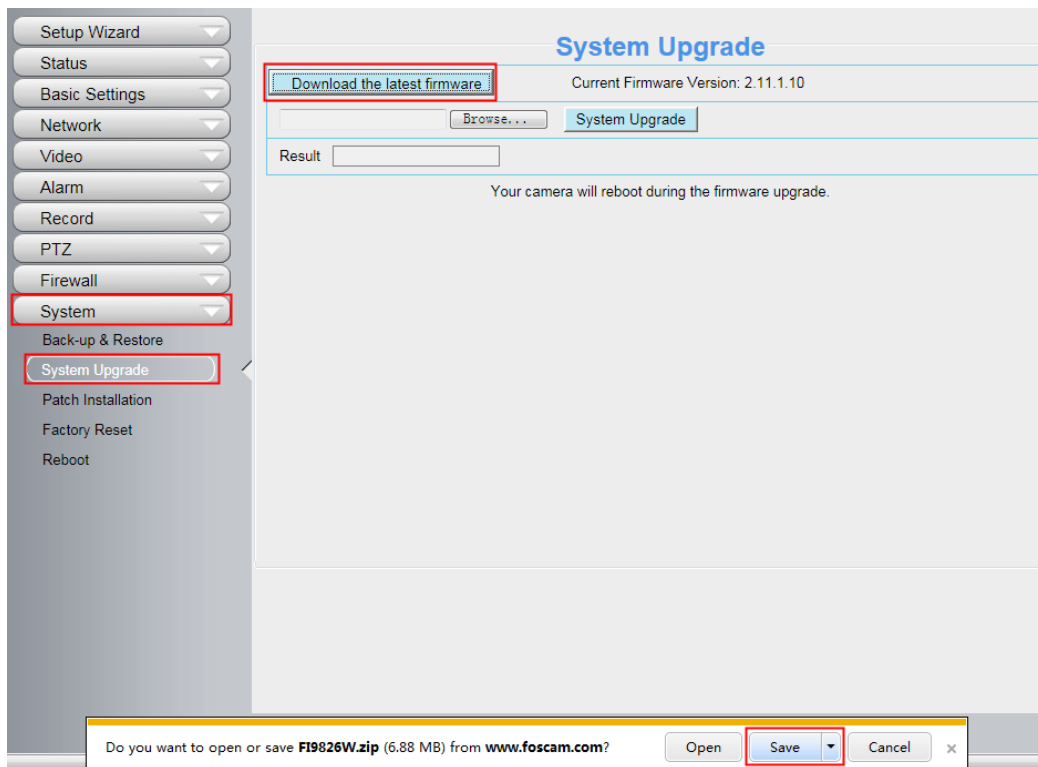

Your current firmware version will be displayed on your screen. You may go to the **Status** → **Device Information** page to check for the latest firmware versions available.

Click **Browse**, choose the correct bin file and then click **System upgrade**.

Don't shut down the power during upgrade. After upgrading, you can see the upgrade result.

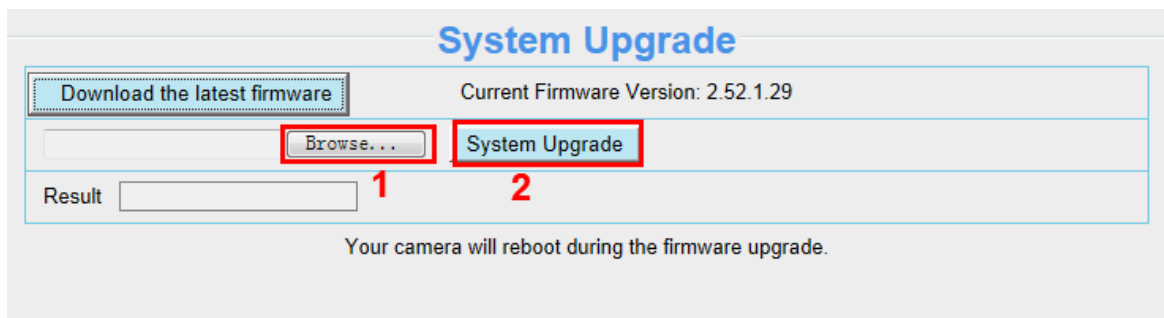

Upgrade Firmware by Equipment Search Tool

Double click the Equipment Search Tool shot icon , select the Camera IP that you want to upgrade the firmware. Then select Upgrade Firmware and enter the username and password, choose the firmware file, and upgrade.

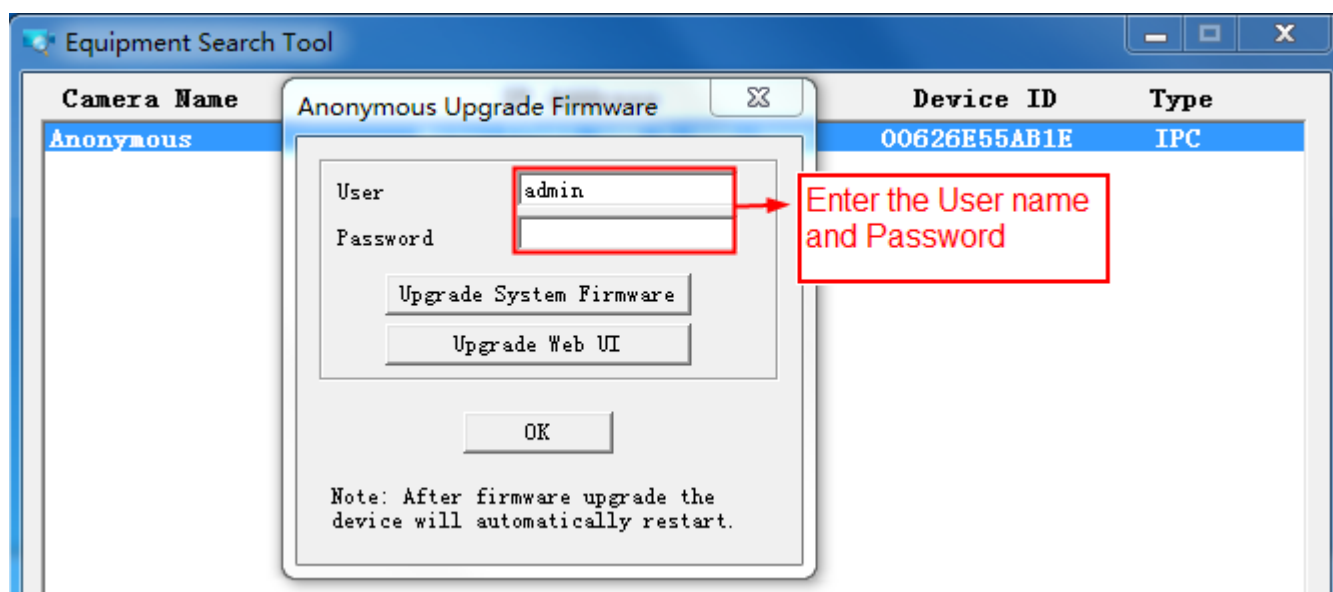
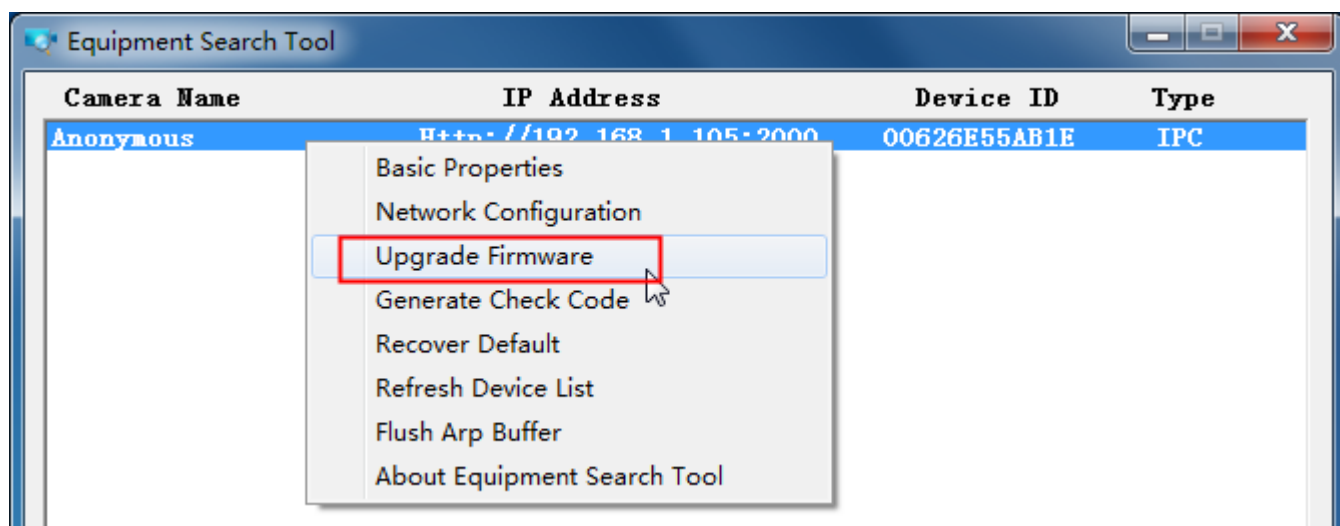

CAUTION: We recommend that you regularly update your camera to the latest available software and firmware versions to help ensure the best experience for your camera.

NOTES:

- Please ensure you have download the correct firmware package for your camera before upgrading. Read the upgrade documentation (readme.txt file) in the upgrade package before you upgrade.
- Upon downloading the firmware check the sizes of the .bin files. They must match the size in the readme.txt file. If not, please download the firmware again until the sizes are the same. Your camera will not function correctly if a corrupt .bin file is used.
- Never shut down the power of the camera during upgrade until the IP camera restart and get connected.
- After upgrade successfully, please uninstall the old plugin and re-install it, then reset the camera to the default factory settings before using the camera.

4.10.3 Patch Installation

Click "Browse" to select the correct patch file, and then click "Install Patch" to install the patch. Do not turn off the power during it installing. After installing is complete, you will receive a system prompt.

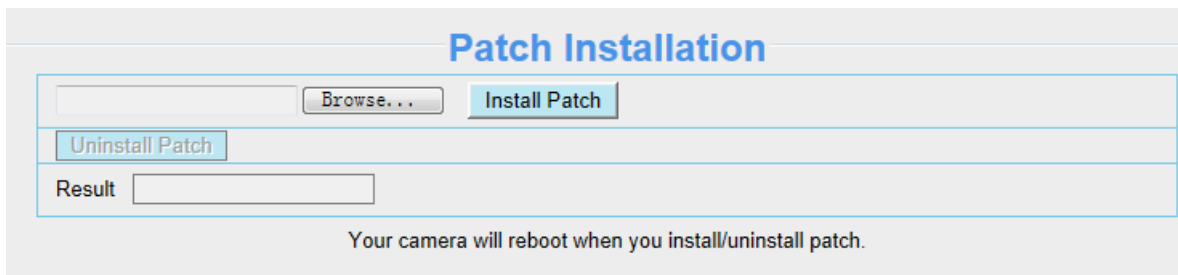

4.10.4 Factory Reset

Click All reset and all parameters will return to factory settings if selected. This is similar to press the Reset button on the bottom of the camera.

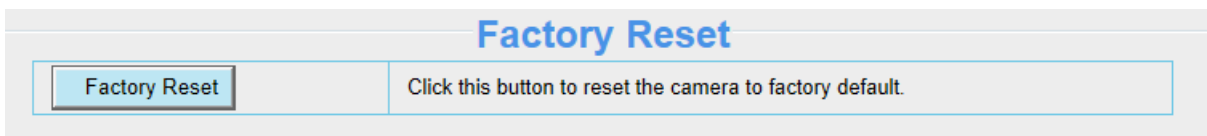

4.10.5 Reboot

Click Reboot System to reboot the camera. This is similar to unplugging the power to the camera.

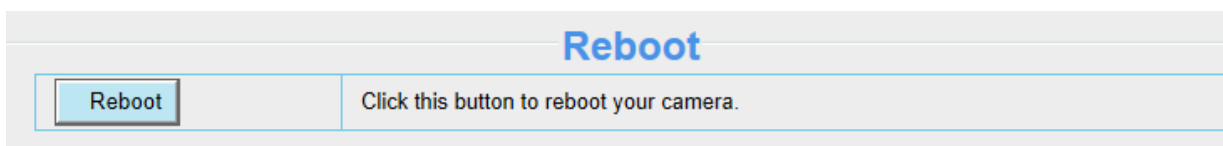

5 Playback

On this page you can view the record files stored in the SD card.

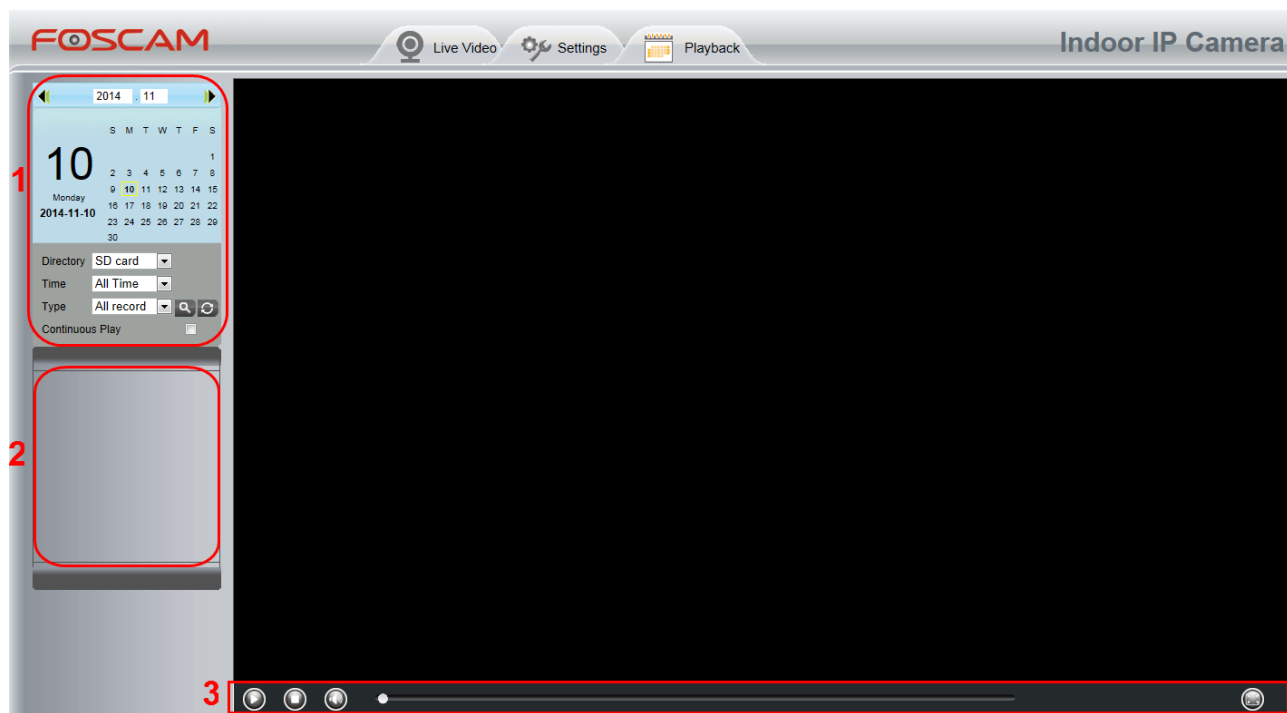

Section 1 Define the Record files time and Type

Directory : The storage path of record files

Time : Here supports three types: current day, current month and All records. Another way, select the time on the time&date manually.



Type : The type of records files, Here supports two types: Normal record, Alarm record and All records.

 : Click this button to search all record files satisfy the conditions you selected.

Continuous Play: Select the checkbox to play continuously all the record files.

Section 2 Search record files

On this panel you can see all record files satisfy the conditions you set.

Section 3 Play/Stop/Audio/Full screen buttons

Please select one record file before use these buttons.



Click this button to play the record files



Click this button to stop the record files



Open or stop audio



Click this button to make full screen, and double click left mouse to exit full screen.

6 Appendix

6.1 Frequently Asked Questions

NOTE: Any questions you would meet, please check Network connections firstly. Check the working status revealed by the indicators on the network server, hub, and exchange. If abnormal, check the network connections.

6.1.1 Equipment search tool cannot find the camera

After power on camera and connect it to router by Ethernet cable, open Equipment Search Tool it cannot find any camera IP address. Shows a blank window like below.

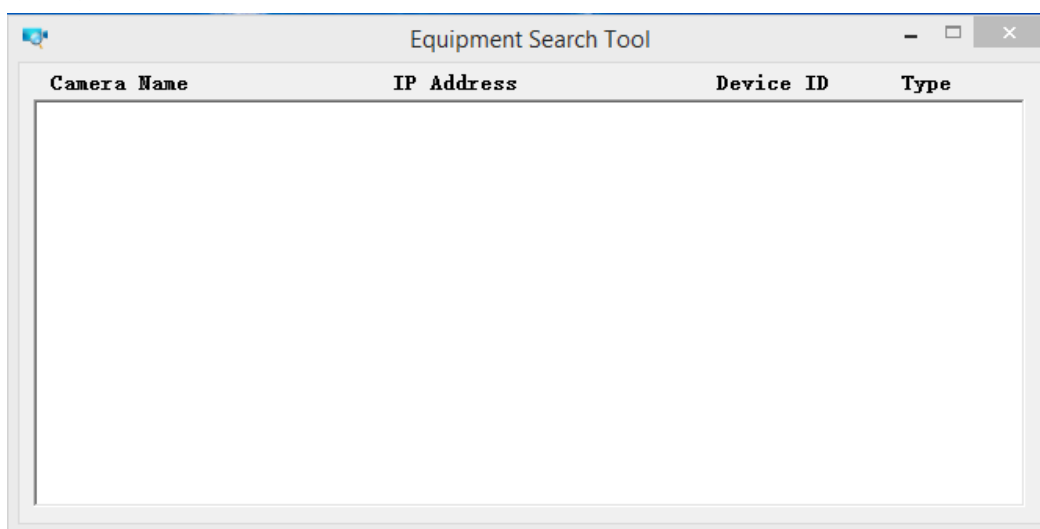

This is usually because camera doesn't get an IP in same network segment as the computer. Please follow below steps to fix the problem.

1. Make sure both camera and computer are connected to same router.
2. Make sure camera's connected to router properly and camera status is normal.
For indoor pan/tilt cameras, when powered on you will see a red power light and camera will pan/tilt. And on LAN port you'll see a blinking orange light and a solid green light.
3. Reset camera to have a check. Just keep pressing rest button on camera with power on for about 30 seconds till it reboot. Reset button is usually on back/bottom of camera, or on the end cords.
4. Try another Ethernet cable or hook into another LAN port on router.
5. Make sure the router DHCP server is enabled and there is no Mac address filter.
Check router's DHCP list as well, to see if you can find camera's IP address there.
If yes, please try to log-in the camera directly by manually input the IP address and port (default http port: for SD camera is 80, for HD camera is 88) of camera into address bar of web browser.
6. Please turn off any virtual machine or multiple connection (use only wired or wireless connection) that is running on computer.
7. At latest make sure there's no firewall is blocking Equipment Search Tool or other search tool conflicts with it.

6.1.2 Install plugin for Internet Explore

Suggest use IE browser to log in the camera and install the plugin for the first time, then you can use it on other browser as well. Just remember to allow the plugin to run. See below for steps to install plugin via IE browser.

Step 1: User IE browser to log in the camera for the first time, it will prompt to ask your install the plugin on the bottom of IE browser.

Step 2: Click **Install** to continue the installation of the .exe plugin.

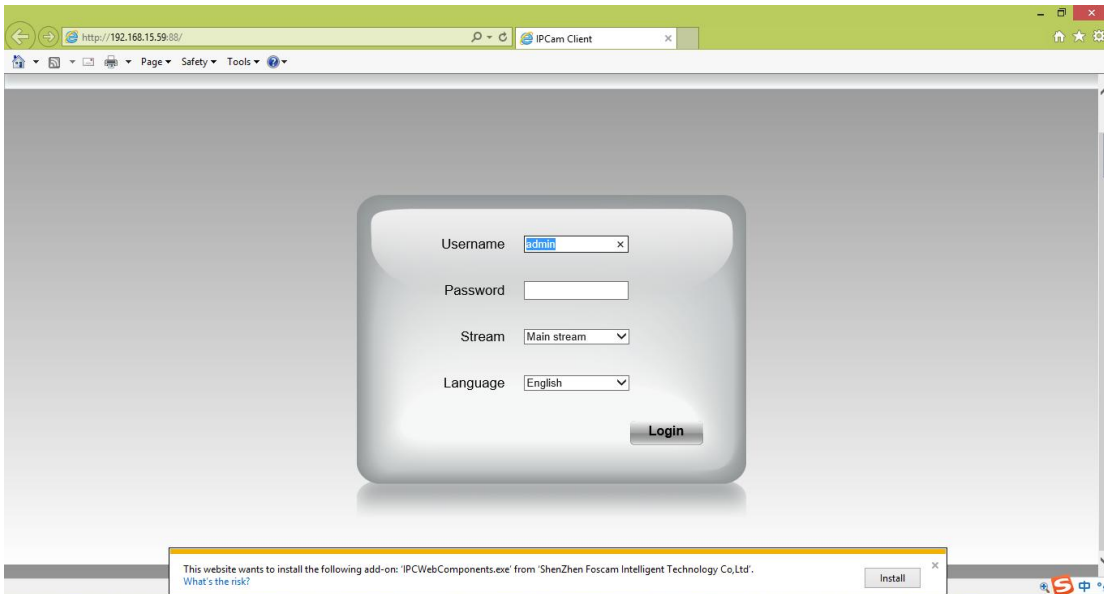

Step 3: Follow the Setup Wizard to finished installing the plugin

Note: When starting to install the plug-in, it will force to close the IE browser. Please click **Yes** to close the IE browser firstly.

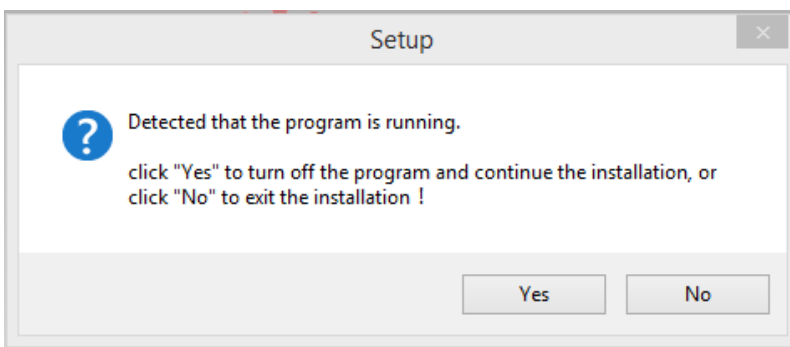

And click **Next** to follow the setup wizard.

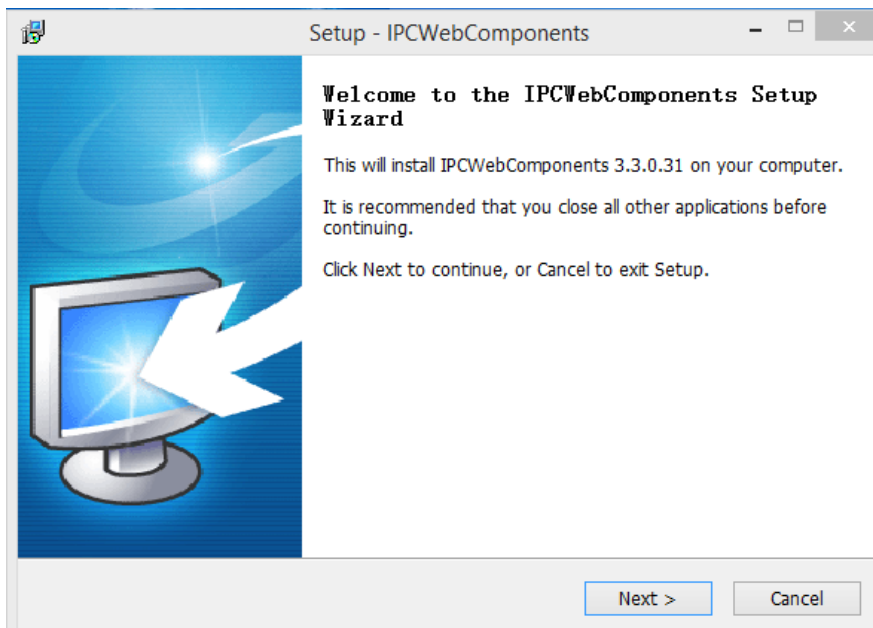

Step 4: Click **Finish** and reboot IE browser to log in the camera.

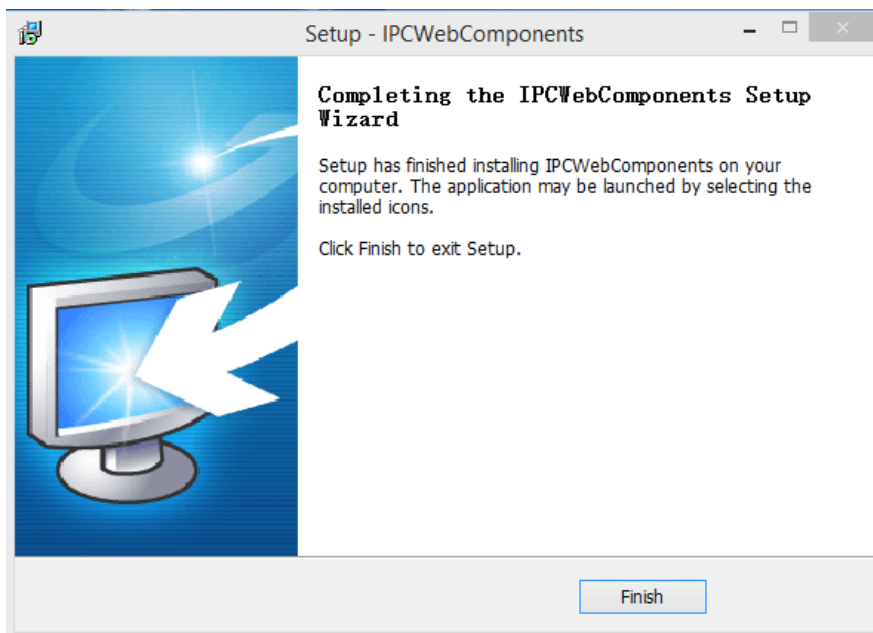

Note, for Safari on MAC OSX it'll show a link "Plugins are not found, click me to download" just above login windows of the camera. Please click it to download plugin and follow wizard to install. See this link for help if after installed plugin but still cannot login camera:

<http://www.foscam.com/faqs/view.html?id=14>

6.1.3 Unable to connect to router wirelessly

After setup wireless configuration, and input the wireless password correctly, save the settings. Normally, after you disconnect the Ethernet cable, wait for few minutes camera will show up again in Equipment Search Tool (or show up in router's DHCP client list/LAN list) with a new IP address. That indicates your camera's connected wirelessly.

If not, please follow below steps to help camera connect wirelessly.

Step1: Please make sure wireless signal is strong enough to connect with.

- (1) Make sure the camera antenna is fixed well;
- (2) Best to keep the distance between the camera and router in 2~3 meters while setup;
- (3) There's no interference or obstacles from house appliance or walls;

Step2: Please check if the frequency band of the wireless signal is 2.4GHz.

Our cameras only support connecting to 2.4GHz frequency wireless band. If your wireless router is dual band, that supports two frequency band 2.4GHz and 5GHz.

Please set the 2.4GHz and 5GHz with different SSIDs, and make sure configure camera to connect with the 2.4GHz SSID.

Step3: Please check if your wireless password contains special characters.

Remove special character in SSID and wireless password to have a try.

Step 4: Reboot camera and router to have a check.

If above are all confirmed, power off and on the camera and router may help camera to connect.

Step 5: Please log-in the router and check if the MAC filter feature is enabled.

Camera has wired and wireless MAC, they are different. If your router has wireless MAC filtering turned on, it'll block camera to connect. Please turn it off, or add camera's MACs in the allow list.

Step 6: Please change the wireless channel, and the wireless encryption of router to have a try.

Change channel helps reduce influence from nearby WiFi networks, you can try 3,6,or 11 for example.

As for encryption, suggest use WPA2/PSK AES.

Step7: At last reset camera to default, and please try re-configure the wireless settings again.

6.1.4 Forgot camera's user name and password

Camera can be hard reset to default settings, when you forgot camera's login user name and password.

Below are the steps:

- (1) Keep power on camera;
- (2) Press and hold reset button of camera for 30 second, till it reboots. Reset button is on bottom, or back, or end cords of the camera.
- (3) Once reset, camera will be restored to default settings. And default username is admin, no password (leave password blank).

6.1.5 How to setup alarm recording to SD card

For the cameras that support SD card, we can save alarm recording on SD card and below are the steps to set it up:

Step 1: Setup the Motion Detection Settings

Please go to **Settings** > **Alarm** > Motion Detection menu.

- (1) Click **Enable**.
- (2) Choose **Recording** for the alarm action.

- (3) Set the Detection Area
- (4) Set a Schedule.
- (5) Click **Save** to save the settings.

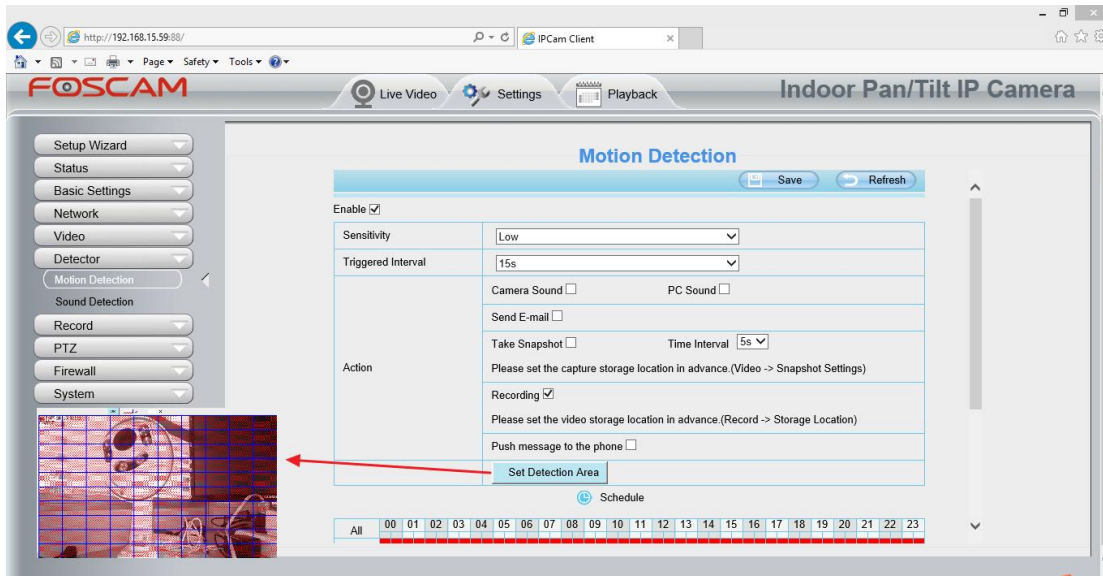

Note:

- 1) Please DO NOT forget to set the alarm schedule, the alarm schedule is red.
- 2) Please make sure your camera time is correct.
- 3) Please DO NOT forget to set the alarm area, the detected area is covered by the red grids. Or for some models you can setup 3 detection zones in total.

Step 2: Setup the Storage Location

Go to **Settings > Record > Storage Location**, and set the “Recording Location” to “SD card and click **Save**.

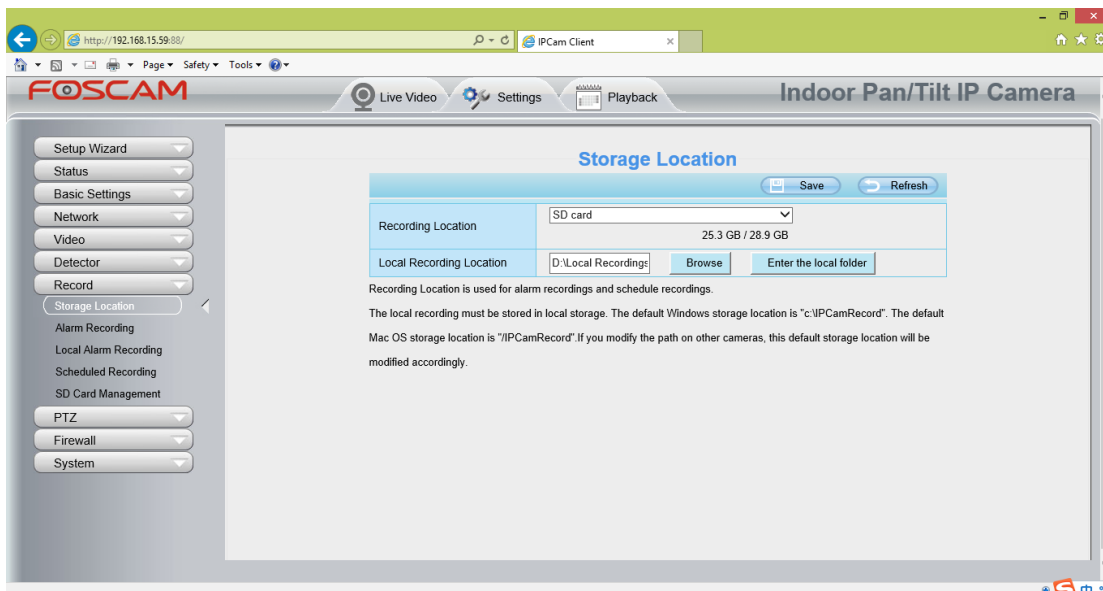

Note:

SD card needs format correctly so it'll be identified by camera, and has enough space for saving the recordings. It's suggested to use FAT32 for 4G~32G SD card and exFAT for 64G and above SD card.

6.1.6 How to setup alarm Emails

Setup alarm Emails, when camera detects a motion it'll send Email with snapshot to inform about the motion alarm. Steps as below.

Step 1: Setup Mail Settings

Before you set, please make sure that your email for sender enabled SMTP. And get your Email SMTP server, SMTP port, TLS information ready.

Please go to **Settings > Network > Mail Settings** menu to setup your email firstly.

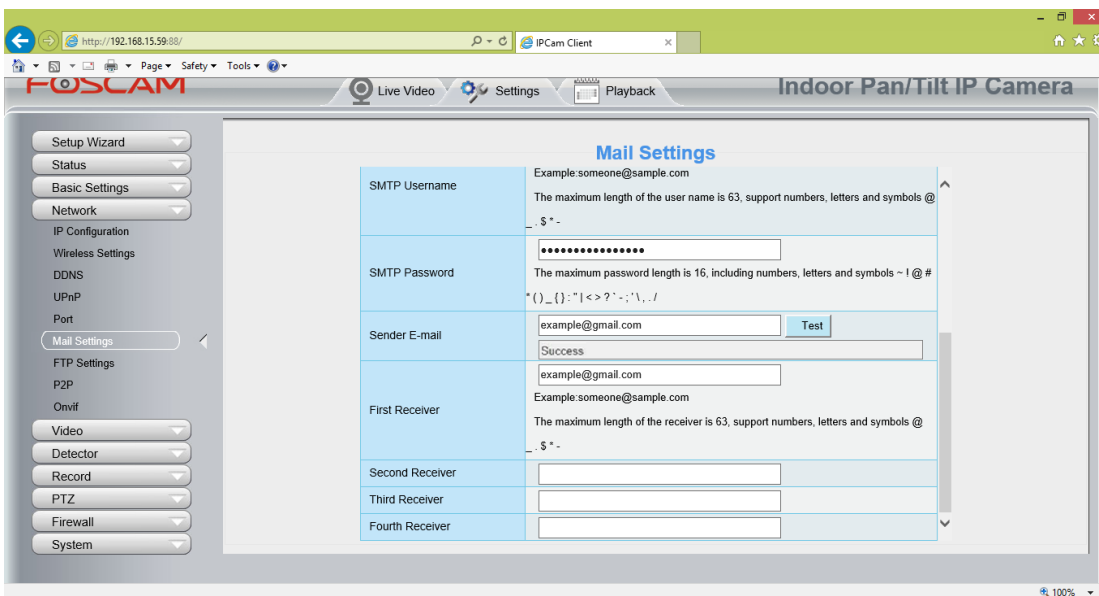
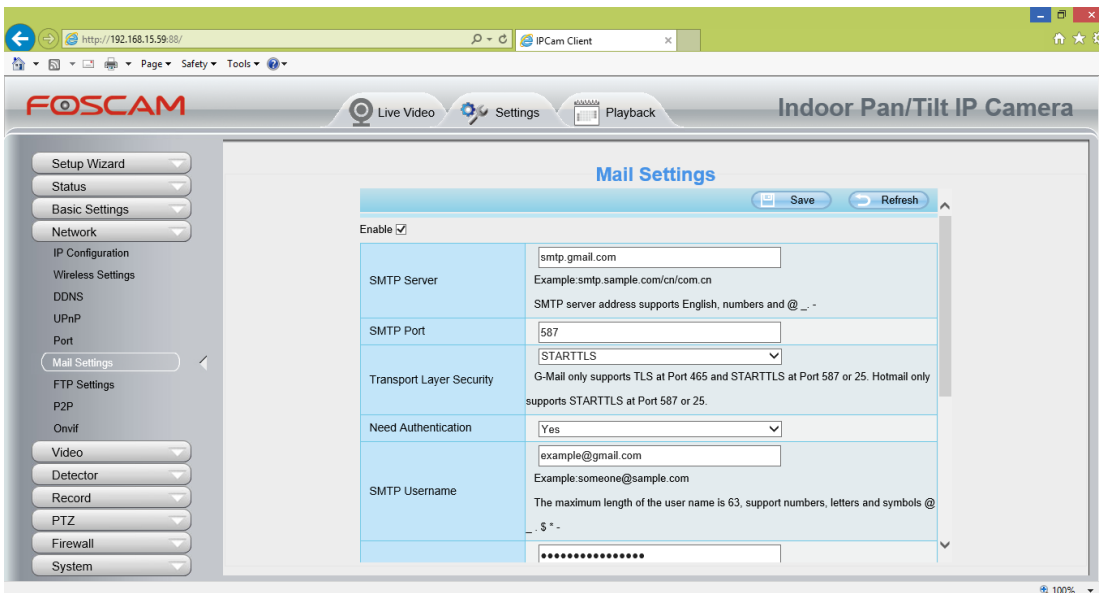

Note:

- (1) Please make sure that your sender email supports SMTP;
- (2) Please click on **Save** before you click on **Test**;
- (3) Make sure the test result is success.
- (4) After succeed, you will receive a test email in the mailbox of Sender.

Step 2: Setup the Motion Alarm Settings

Please go to **Settings > Alarm > Motion Detection** menu:

1. Click **enable**,
2. Choose **Send E-mail** for the alarm action,
3. set your detection area,
4. Set your schedule.

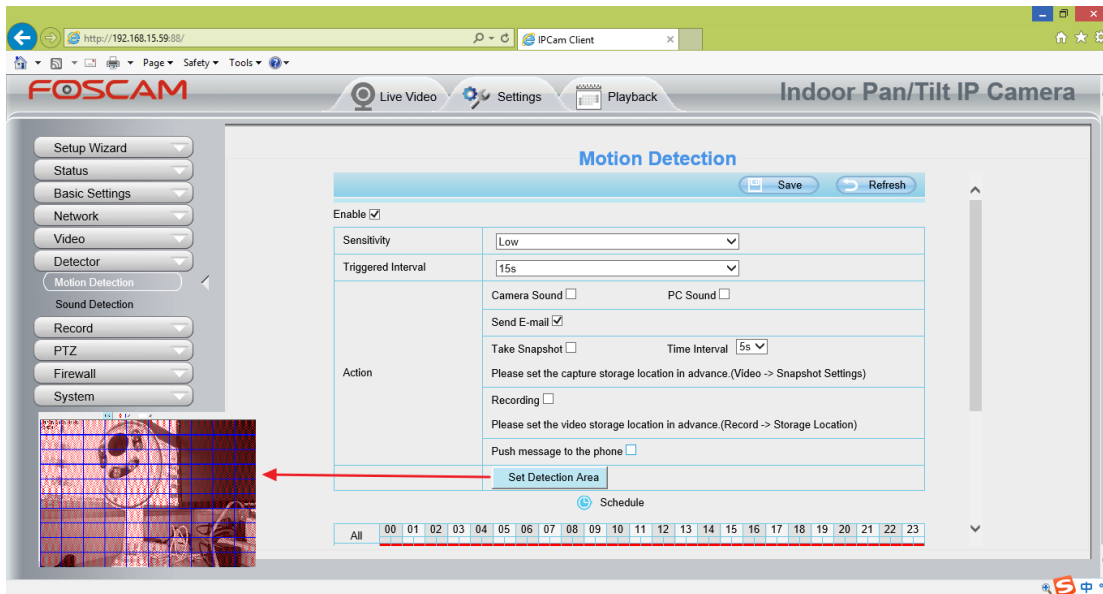

Do not forget to click on **Save** after you finish settings.

If there is motion trigger, camera will alarm and you can receive alarm emails.

Note:

- (1) Please DO NOT forget to set the alarm schedule, the alarm schedule is red.
- (2) Please make sure your camera time is correct.
- (3) Please DO NOT forget to set the alarm area, the detected area is covered by the red grids. Or for some models you can setup 3 detection zones in total.

6.1.7 Camera is not displaying image

Camera unable to show live image on web browser cloud be caused by multiple factors.

- (1) Plugin is not installed or running properly.

Please install plugin first, go to **IE Browser > Tool > Internet Option > Security > Custom Level > ActiveX control and Plug-ins**. Three options of front should be set to be **Enable**, The ActiveX programs read by the computer will be stored. As follows:

Enable: Download unsigned ActiveX controls.

Enable: Initialize and script ActiveX controls not marked as safe.

Enable: Run ActiveX controls and plug-ins.

- (2) Low network bandwidth that's unable to transfer image. Please lower resolution of the camera.
- (3) IR-cut is stuck at night when IR lights are on. In this case, manually turn off and on IR lights a few times.
- (4) Also, if camera's firmware is too old that doesn't support the browser and unable to install plugin will cause the same issue. Please update firmware of the camera to latest first.

6.1.8 Unable to connect camera remotely using Foscam app

Foscam P2P cameras allow users to connect camera remotely using Foscam app without extract setup like port forwarding. When it unable to connect remotely, below tips can help app establish the connection:

- (1) Update app and camera's firmware to latest version,
- (2) Power off the camera then power back on,
- (3) Delete camera from app then re-add it back, also lower camera's resolution.

6.1.9 Camera is added by others

When use myfoscam.com cloud or Foscam app, one camera can only be added to one account at the same time. To solve error "This camera has already been added by another account" when add camera to Foscam app or cloud, please send a clear photo of camera's model sticker to Foscam support email support@foscam.com to unbind it.

More FAQs are available here:

<https://www.foscam.com/faqs/index.html>

6.2 Default Parameters

Default network Parameters

IP address: obtain dynamically

Subnet mask: obtain dynamically

Gateway: obtain dynamically

Username and password

Default admin username: admin with a blank password

6.3 Specifications

ITEMS		
Image Sensor	Sensor Type	1/2.7" CMOS
	Display Resolution	2.0MegaPixels (1920*1080)
	Frame Rate	25fps
	Min. Illumination	0 Lux (With IR Illuminator)
Lens	Lens Type	f:2.8~12mm,F1.4
	Angle of View	Horizontal:36°~101° Diagonal :41°~117°
	Night Vision	20pcs IR-LEDs, IR Range up to 10m (33ft)
Video	Image Compression	H.264

	Resolution	1080P(1920x1080) ,720P(1280 x 720), VGA(640 x 480), QVGA(320 x 240)
	Stream	dual stream
	Image adjustment	The hue, brightness, contrast, saturation, sharpness are adjustable
	Flip image	flip and mirror
	Infrared mode	Automatic or manual
	manual Pan/Tilt Angle	(Pan/Tilt angle: H=300°, V=100°)
Audio	Input/Output	Supports two-way audio Built-in Mic & Speaker
	Audio Compression	PCM/G.726
Network	Ethernet	One 10/100Mbps RJ45 port
	Wireless Standard	2.4G: IEEE802.11b/g/n 5G: IEEE802.11a/n/ac
	Data Rate	2.4GHz: IEEE802.11b: 11Mbps(Max.); IEEE802.11g: 54Mbps(Max.); IEEE802.11n: 150Mbps(Max.). 5GHz: IEEE802.11a: 54Mbps(Max.); IEEE802.11n: 150Mbps(Max.); IEEE802.11ac: 433Mbps(Max.).
	Frequency bands	2412-2472MHz
	Maximum power	18dBm
	Wireless Security	WPA, WPA2
	Wireless Setup	Supports EZLink wireless setup
	Network Protocol	IP、TCP、UDP、HTTP、HTTPS、SMTP、FTP、DHCP、RTSP、ONVIF
	Remote Access	P2P
System Requirements	Operating System	Microsoft Windows XP, 7, 8; Mac OS; iOS、Android
	Browser	IE8 and above version; Firefox; Chrome; Safari.
Other Features	Motion Detection	Alarm via E-Mail, upload alarm snapshot to FTP
	WDR	Improve image clarity in complex scenario
	Magic Zoom	A Magic digital zoom function rivaled Optical zoom
	User Accounts	Three levels user role
	Firewall	Supports IP Filtering
	Storage	128G Micro SD card, local and FTP storage
	Reset	Reset button is available
Power	Power Supply	DC 5V/2.0A
	Power Consumption	<6W

Physical	Dimension(LxWxH)	115.8(L)*103.2(W)*118.6(H) mm (2.6x4.1x4.7in)
	Net Weight	380g(0.84lb)
Environment	Operating Temperature	-10°C ~ 50° (14°F ~ 122°F)
	Operating Humidity	20% ~ 85% non-condensing
	Storage Temperature	-20°C ~ 60° (-4°F ~ 140°F)
	Storage Humidity	0% ~ 90% non-condensing
Certification	CE, FCC, RoHS,WEEE	

Attention: Power adapter should be used between 0°C-40°C, and 5%-90% relative humidity.

6.4 CE & FCC

Electromagnetic Compatibility (EMC)

FCC Statement



This device complies with FCC Rules Part 15. Operation is subject to the following two conditions.

- This device may not cause harmful interference
- This device must accept any interference received, including interference that may cause undesired operation.

This equipment has been tested and found to comply with the limits for a Class B digital device, pursuant to Part 15 of the FCC Rules. These limits are designed to provide reasonable protection against harmful interference when the equipment is operated in a commercial environment. This equipment generates, uses, and can radiate radio frequency energy and, if not installed and used in accordance with the installation manual, may cause harmful interference to radio communications. Operation of this equipment in a residential area is like to cause harmful interference, in which case the user will be required to correct the interference at his own expense.

FCC Caution

Any changes or modification not expressly approved by the party responsible for compliance could void the user's authority to operate this equipment.

This equipment complies with FCC radiation exposure limits set forth for an uncontrolled environment.

This equipment should be installed and operated with minimum distance 20cm between the radiator& your body.

This transmitter must not be co-located or operating in conjunction with any other antenna or transmitter.

CE Mark Warning



This is a Class B product. In a domestic environment, this product may cause radio interference, in which case the user may be required to take adequate measures.

6.4 Warranty

FOSCAM values your business and always attempts to provide you the very best of service. No limited hardware warranty is provided by FOSCAM unless your FOSCAM product ("product") was purchased from an authorized distributor or authorized reseller. Distributors may sell products to resellers who then sell products to end users. No warranty service is provided unless the product is returned to an authorized return center in the region where the product was first shipped by FOSCAM or to the point-of-purchase, which may have regional specific warranty implications.

If you purchase your FOSCAM product from online store, please contact the point-of-purchase and ask for return/replacement/repair service.

Limited Hardware Warranty

- FOSCAM products are warranted to be free from manufacturing defects in materials and workmanship starting from the shipping date of FOSCAM.

This limited hardware warranty does not cover:

- Software, including the software added to the products through our factory-integration system, software that included in the CD, etc.
- Usage that is not in accordance with product instructions.
- Failure to follow the product instructions.
- **Normal wear and tear.**

Return Procedures

- Please read FOSCAM warranty policy & policy of your reseller first before sending items back to point-of-purchase.
- Customer must first contact point-of-purchase to obtain a Return Merchandise Authorization (RMA) number before returning the product. If the product you received is suspected to be defective and the product warranty has not expired, The RMA number will allow your reseller to track your return much easier and help them expedite processing your request.
- After receiving your RMA case number, pack the item(s) very well with the original box and all the original accessories included such as power adapters, brackets, cables, manuals, and driver CD disks.
- Write your RMA number and the return reason (the problem of the product) on the warranty card along with the complete package to send them back.

Replacement Services

- **If customers ask for replacement service, please contact point-of-purchase and follow their**

policy.

- Our technicians will inspect all items returned for replacement requests. If the returned product is found in working order, we will return the same item received. However customers shall be responsible for all shipping & handling charges incurred for getting the units back to customers.
- If returned products are found defective, we will replace the product and assume the shipping cost for sending back the replacement unit to customers.
- If for any reason, we are unable to provide a replacement of the original returned item(s). You will have a choice for a “Substitute” item at the same equal value.
- We do not provide exchange and replacement due to normal hardware upgrade according the market after 14 days after the product is delivered.
- Our technicians will test the product before send out the replacement, any other demand for more than two times replacement for the same product during replacement limit will be rejected.
- **Replaced products are warranted from the balance of the former warranty period.**

Warranty Forfeiture

- Warranty is void if purchase from unauthorized distributor or reseller.
- Warranty is void if trade-mark, serial tags, product stickers have been removed, altered or tampered with.
- Warranty is void for mishandling, improper use, or defacing the product.
- Warranty is void for physical damage, altered, either internally or externally, improper or inadequate packaging when returned for RMA purposes.
- Warranty is void if damage has resulted from accident, dismantle, abuse, or service or modification by someone other than the appointed vendor, source, fission or the spare part has been over the period of warranty.
- Warranty is void if product is damaged due to improper working environment or operation. (For example, improper temperature, humidity, unusual physical or electrical stress or interference, failure or fluctuation of electrical power, static electricity, using wrong power adapter, etc.)
- Warranty is void if damaged by the use of parts not manufactured or sold by FOSCAM.
- Damage caused by improper installation of third-party products.
- Warranty is void if damaged for irresistible cause, such as earthquake, fire, lightning, flood, etc.
- Product beyond limited warranty.

Shipping Fee

- If products are defective or damaged under normal use or operation in the replacement limit, distributors or resellers are responsible for the shipping cost the product back to customers, customers should assume the shipping cost send the product to the point-of-purchase.
- During replacement limit, if customers ask for replacement due to the product does not fit for customer’s personal expectation, customers should responsible for both shipping fee.
- Customers shall be responsible for both shipping fee if their product beyond the replacement limit but still in warranty limit.

Repair Service Out Of Warranty

- FOSCAM provide extra repair service for product that out of warranty, it is chargeable. The total fee contains device cost and service fee. Device cost (including accessories) is the standard uniform

price provide by FOSCAM.

- Different region may have different service fee, please contact the point-of-purchase to confirm that before you ask for this service.
- Our technicians will quote the total price after detect the product, If customers refused to repair after the quotation, customers need pay for the test fee, \$3.5/hour. If agree with the quotation, test will be free.
- Repaired product out of warranty will obtains 3-month warranty from the date of the product back to customers.

Limitation of Liability

- FOSCAM is not responsible for other extra warranty or commitment promised by resellers, if your reseller promised some extra commitment or warranty; please ask for written documents to protect your rights and interests.
- FOSCAM does not offer refunds under any circumstances. Please contact the point-of-purchase and follow their refund/return policy.
- FOSCAM shall not be liable under any circumstances for any consequential, incidental, special or exemplary damages arising out of or in any connection with this agreement or the products, including but not limited to lost profits, or any claim based on indemnity or contribution, or the failure of any limited or exclusive remedy to achieve its essential purpose or otherwise. Purchaser's exclusive remedy, as against FOSCAM, shall be the repair or replacement of defective parts. If FOSCAM lists a product on its website specification in error or that is no longer available for any reason, FOSCAM reserves the right to explain it without incurring any liability.

All rights reserved. FOSCAM and the FOSCAM logo are trademarks of ShenZhen FOSCAM Intelligent Technology Limited., registered in the U.S. and other countries.

6.5 Statement

You are advised to be cautious in daily life, keep personal account information carefully, do not share personal account easily. Change passwords of your account and equipment periodically, and upgrade equipment firmware to strengthen security consciousness.

Our company makes no warranty, implied or otherwise, that this product is suitable for any particular purpose or use. You need to abide by the relevant laws and regulations of the use restrictions when using Foscam cameras. Our company takes no responsibility of illegal activities by using our products.

Our company takes no responsibility of the loss by force majeure, such as failure or faults of telecom system or the Internet network, computer viruses, malicious attacks of hackers, information damage or loss, and faults of computer system.

Foscam company does not need to take any responsibility of the special, incidental or corresponding loss by the products of our company or any software provide by our company, including but not limited to operating loss, profit or purpose. The company only takes the responsibility applicable to national and local legal requirements.

Our company takes no responsibility of the loss caused by the following at any time:

- 1) loss of purchases;
- 2) loss of intangible property damage, such as data, programs;
- 3) loss of compensation claimed by third-party customers.

Delete images, format the memory card or other data storage devices does not completely remove the original image data. You can restore deleted files from discarded the storage device by commercial software, but which will potentially lead to personal image data used maliciously by others. The privacy of the data security belongs to user responsibility, the company takes no responsibility.

Parts mentioned in this statement should not be understood by the configuration description of the product purchased by the customer, the product configuration must accord to the specific models purchased by the customer.

Without the prior written permission of Foscam company, all the contents of relevant operating instructions manual affiliated to the product must not be reproduced, transmitted, transcribed or stored in a retrieval system, or translated into other languages.

Our company will reserve the right to improve and modify the product and corresponding manuals. The company reserves the right of final interpretation on our products.

7 Obtaining Technical Support

While we hope your experience with the IPCAM network camera is enjoyable and easy to use, you may experience some issues or have questions that this User's Guide has not answered.

If you have problem with FOSCAM IP camera, please first contact FOSCAM reseller for solving the problems. If our reseller cannot provide service, please contact our service department:

support@foscam.com



CE Certificate Website: <http://www.foscam.com/company/ce-certificate.html>

Exporter and Importer Information Opened to Public:

<http://www.foscam.com/company/open-information.html>